

BIFFI FAIL SAFE ELECTRIC ACTUATORS, MODEL EFS2000V4

INSTRUCTION AND OPERATING MANUAL



INDEX

| | |
|---|----|
| 1. General safety instructions..... | 1 |
| 2. Machine description..... | 3 |
| 3. Storage and pre-installation | 4 |
| 4. Assembling the actuator onto the valve | 5 |
| 5. Adjustment of angular stroke | 6 |
| 6. Installation..... | 7 |
| 7. EFS operation | 9 |
| 8. Actuator operation | 13 |
| 9. Optional modules | 16 |
| 10. Local controls..... | 20 |
| 11. Set-up menu..... | 26 |
| 12. View menu | 27 |
| 13. Set-up routines..... | 31 |
| 14. View routines | 47 |
| 15. Local indicator setting | 57 |
| 16. Manual operation and fail-safe speed setting | 58 |
| 17. Maintenance and trouble-shooting..... | 61 |
| 18. Exploded view and parts list..... | 67 |
| 19. Lubrication..... | 70 |
| 20. Operational tests and inspections..... | 70 |
| 21. Disassembling and demolition..... | 70 |

1 GENERAL SAFETY INSTRUCTIONS

1.1 Manufacturer

The manufacturer with respect to the Machinery Directive 2006/42/EC is Biffi Italia, as specified on the machinery label.

1.2 Device intended use

The devices to which this instruction and operating manual applies are the EFS2000v4 Fail Safe Electric Actuators, which are designed to operate any kind of quarter-turn industrial valves for use in Emergency Shut Down (ESD) applications in heavy industrial, chemical, petrochemical, food, water and power generating plants.

Biffi Italia will not be liable for any possible damage or physical injury resulting from use in other than the designated application or by lack of care during installation, operation, adjustment and maintenance of the machinery. Such risks lie entirely with the user. Depending on the specific working conditions, additional precautions may be required.

The EFS2000v4 is produced by Biffi Italia and identified on the proper label by the product designation: EFS xxx/yyyy-zz

WARNING!

It is assumed that the installation, configuration, commissioning, maintenance and repair works are carried out by qualified personnel and checked by responsible specialists.

IMPORTANT

This manual gives basic information for EFS2000v4 configuration; more detailed information for configuration and control of the electric actuator part ICON2000 are included on the VCIOM-01232 which form part of the mandatory instructions documentation.

The EFS2000v4 is designed in accordance with the applicable international rules and specifications but in any case the following regulation must be observed:

- The general installation and safety regulations.
- The plant specific regulations and requirements.
- The proper use of personal protective devices (glasses, clothing, gloves).
- The proper use of tools, lifting and transport equipment.

1.3 Terms and conditions

The manufacturer guarantees each single product to be free from defects and to conform with current goods specifications and regulations as applicable. The warranty period is 12 months from the date of installation by the first user or 18 months from the date of shipment to the first user, whichever occurs first. No warranty is given for products, which have been subject to damages or corrosion due to the improper storage, improper installation,

misuse, or which have been modified or repaired by unauthorized personnel. Repair work due to improper use will be charged at standard rates.

1.4 Manufacturer's liability

The manufacturer declines all liability in the event of:

- Use of the device in contravention of local safety at work legislation.
- Incorrect installation, disregard or incorrect application of the instructions provided on the product nameplate and in this instruction and operating manual.
- Modification of the product without the manufacturer's authorization.
- Work done on the product by unqualified or unsuitable personnel.

BIFFI FAIL SAFE ELECTRIC ACTUATORS, MODEL EFS2000V4

INSTRUCTION AND OPERATING MANUAL

1.5 Applicable standards and regulations

| | |
|----------------|---|
| EN ISO 12100-1 | Safety of machinery - Basic concepts, general principles for design. Part 1- Basic terminology, methodology. |
| EN ISO 12100-2 | Safety of machinery - Basic concepts, general principles for design. Part 2- Technical principles and specification. |
| EN60204/1 | Electrical equipment of industrial machines. Part1- General requirements |
| 2006/42/EC | Machinery Directive. |
| 2014/35/EU | Low Voltage Directive |
| 2014/30/EU | EMC Directive |
| 2014/34/EU | ATEX Directive |

Specific type of protection is printed on the labels, as follows:

- Ex d IIB Txx with all enclosures in "explosion proof" version
- Ex d IIC Txx with all enclosures in "explosion proof" version
- Ex de IIB Txx with enclosures in "explosion proof" version and terminal board enclosure in "increased safety" version. (only for enclosure of actuator ICON2000)
- Ex de IIC Txx with enclosures in "explosion proof" version and terminal board enclosure in "increased safety" version. (only for enclosure of actuator ICON2000)
- All the above version can be equipped with an additional battery in an intrinsically safe enclosure according to IEC 60079-11. (only for actuator ICON2000)

1.7.2 Label for EFS2000v4

Marking description:
 0080 = Notified body for ATEX
 II = Group II (surface)
 2 = Category 2 apparatus
 G = Explosive atmosphere by gas
 D = Explosive atmosphere by dust
 IP 66/68 = Degree of protection

1.6 Installation in hazardous area

WARNING!

*In case the EFS2000v4 is to be installed in a hazardous area, as defined by the applicable rules, it is mandatory to check if the nameplates of the EFS2000v4 and associated ICON2000 specify that the assembly is suitable to be installed in hazardous area with the indication of appropriate degree of protection.
 Maintenance and repair works must be carried out by qualified personnel and checked by responsible specialists.*

The EFS2000v4 version suitable for installation in hazardous area, with the associated electric actuator type ICON2000 and accessories, is designed according to all the applicable Standards EN/IEC 60079-0, EN/IEC 60079-1, EN/IEC 60079-7, EN/IEC 60079-11, EN/IEC 60079-31, EN 13463-1 and EN 13463-5.

The above versions of EFS 2000v4 are suitable to be safely installed in hazardous areas preventing the risk of explosion in the presence of gas or ignitable dusts.
 EFS 2000v4 have IP66/68 degree of protection according to EN/IEC 60529. IPX8 according to EN/IEC 60529 is defined for an immersion at a depth of 10 meters and for a duration of 48 hours.

1.7 Marking for application in hazardous area

1.7.1 Label for ICON2000/ICON2000EC

Marking description:
 0080 = Notified body for ATEX
 II = Group II (surface)
 2 = Category 2 apparatus
 G = Explosive atmosphere by gas
 D = Explosive atmosphere by dust
 IP 66/68 = Degree of protection



1.8 Extract from the standard

| Type of hazard | Classification of zones | Categories acc. to 2014/34/EU directive |
|----------------------|-------------------------|---|
| Gas, mists or vapors | Zone 0 | 1G |
| Gas, mists or vapors | Zone 1 | 2G |
| Gas, mists or vapors | Zone 2 | 3G |
| Dust | Zone 20 | 1D |
| Dust | Zone 21 | 2D |
| Dust | Zone 22 | 3D |

BIFFI FAIL SAFE ELECTRIC ACTUATORS, MODEL EFS2000V4

INSTRUCTION AND OPERATING MANUAL

2 DEVICE DESCRIPTION

2.1 General

The EFS2000v4 (Electric Fail Safe) is an electric quarter turn spring return actuator which has the purpose to move the valve in a "fail safe" state (Fail Open or Fail Close), when the system is de-energized.

As it's described in the next sections, several modes for EFS2000v4 are available in order to move the valve in a "fail safe" state but it's important to highlight that the "safety function" with SIL classification is only the one mentioned in the document:

- SM 020 (SIL Safety Manual – Actuator series EFS2000 v4) which clearly defines the EFS2000v4 "safety function" as follow: "The actuator performs the safety function on demand if it delivers a full stroke driven by the spring, moving the valve to the safe position (either closed or open depending upon the valve to be actuated) when the system is de-energized (i.e. cutting the electric supply to the electromagnetic clutch)."

Statement above clearly specify mode of operating the actuator in order to perform the "safety function" (i.e. cutting the electric supply to the electromagnetic clutch).

Note: in the next section of present IOM, only "safety function" (as it's defined here above) will be considered as an action related to an ESD (Emergency Shut-Down) command.

Any other device described in the next sections of present Instructions and Operating Manual which commands the actuator to reach its fail safe state shall not be considered as "Safety Functions".

All these device are not compliant to IEC 61508 requirements, they are not a safety system and they are not SIL classified.

All actions of Shut-Down related to these type of commands or device shall not be considered in an Emergency Condition

Note: in order to avoid misunderstanding, in the next section of present IOM, acronym ESD without any explanation has to be intended with the meaning of Emergency Shut-Down. Where it's specified, acronym ESD has to be intended as EFS shutdown.

The PST (Partial Stroke Test) functionality is also available integrated in the actuator control system in order to check the integrity of the actuator and valve in safety applications. In many cases, however, there was difficulty to find out on site the pneumatic/hydraulic power, while the electric power supply is always available in every industrial plant.

2.2 Main parts description

The EFS2000v4 actuator consists of six main parts:

- A spring return mechanism, which moves the valve in the predefined fail-safe condition when requested by an esd signal or by a power failure.
- A multi-turn electric actuator which operates, through an epicyclic gearing, the valve during normal working conditions and at the same time compresses the spring when the operation is opposite to the fail safe direction.
- An epicyclic gear reduction to increase the torque of the multi turn actuator.
- An electro-magnetic clutch to keep the epicyclic gearing in position during normal operation and release it in case of fail-safe function.
- A hydraulic control group to adjust the fail-safe speed and to manually operate the actuator by means of a hand-pump in case of power failure.

To prevent potential damages a manually operated switch interrupts the automatic operation during the manual operation by a hand-pump.

- A local control and configuration panel, which is used to configure the parameters and to operate locally via OPENCLOSE-STOP push-buttons and 3-position LOCAL-OFF-REMOTE selector the actuator when electric power is present.

2.3 Operating principle

The spring return system is kept in fail safe position by helical springs. During the normal operation the multi-turn turn electric actuator transmits the movement to the valve through the epicyclic gearing reduction and to the spring return mechanism through the rack. Spring return mechanism is based on rack-pinion mechanism; the rack is connected in one side to the spring and in the other side to the hydraulic cylinder; pinion of rack-pinion mechanism is connected to the valve stem.

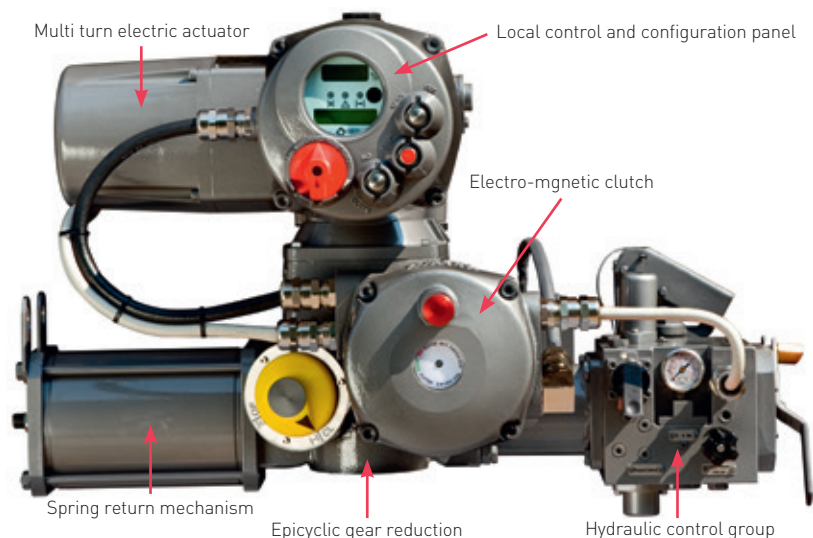

BIFFI FAIL SAFE ELECTRIC ACTUATORS, MODEL EFS2000V4

INSTRUCTION AND OPERATING MANUAL

Input shaft of the epicyclic gearing reduction is connected the multi-turn actuator output shaft; output shaft of the epicyclic gearing reduction is connected to the pinion of rack-pinion mechanism. The female wheel of the epicyclic reduction is reversible: during normal operation it is kept on position by means of an electromagnetic clutch which hold the worm shaft connected to the epicyclic gearing.

The coil of the electromagnetic clutch is normally fed by a direct current from separated external power source, or derived from motor power voltage, through a supply module.

When the ESD condition occurs, the supply to the electromagnetic clutch is cut causing the disconnection of system which hold the worm shaft: in this conditions the epicyclic gearing become reversible causing the movement of the actuator on the fail condition by the effect of the spring. To avoid dangerous shock to the valve during the ESD action, an hydraulic damper is mounted on the spring system, with an adjustable flow control orifice to be set to obtain the specified ESD times.

Position of the valve is continuously monitored both in electric mode, both in fail-safe condition, by means of a position sensor directly connected the EFS2000v4 output drive.

3 STORAGE AND PRE-INSTALLATION

IMPORTANT

Omitting the following procedures will invalidate the product warranty.

3.1 Checks to be carried out on receipt of the actuator

- Check first of all if the information written on the nameplate (models, nominal torque, nominal voltage, degree of protection, etc.) corresponds with the data of the product which is expected.
- If the actuator arrives already assembled onto the valve, the configuration of the mechanical stops and of the electric end of travel has already been made by the person who assembled the actuator onto the valve.
- If the actuator arrives separately from the valve, the configuration of the mechanical stops and of the electric end of travel must be checked and, if necessary, carried out while assembling the actuator onto the valve.
- Check that the actuator has not been damaged during transport. If necessary, repair all damages to the paint-coat, etc.

- Check that the model, the serial number of the actuator and the performance data written on the data-plate correspond with those described on the order acknowledgement, test certificate and delivery note.
- Check that the fitted accessories correspond with those listed in the order acknowledgement and the delivery note.

3.2 Actuator handling

IMPORTANT

The lifting and handling should be made by qualified staff and in compliance with the laws and provisions in force.

WARNING!

The fastening points are appropriate for the lifting of the actuator alone and not for the valve+actuator assembly. Avoid that during the handling, the actuator passes above the staff. The actuator should be handled with appropriate lifting means. The weight of the actuator is reported on the delivery bill.

3.3 Storage procedure

The actuators leave the factory in an excellent working condition and with an excellent finish (these conditions are guaranteed by an individual inspection certificate); in order to maintain these characteristics until the actuator is installed on the plant, it is necessary to observe a few rules and take appropriate measures during the storage period.

- Make sure that plugs are fitted in the air connections and in the cable entries. The plastic plugs which close the inlets do not have a weatherproof function, but are only a means of protection against the entry of foreign matter during transport. If long-term storage is necessary and especially if the storage is outdoor, the plastic protection plugs must be replaced by metal plugs, which guarantee a complete weatherproof protection.

Actuator's lifting points

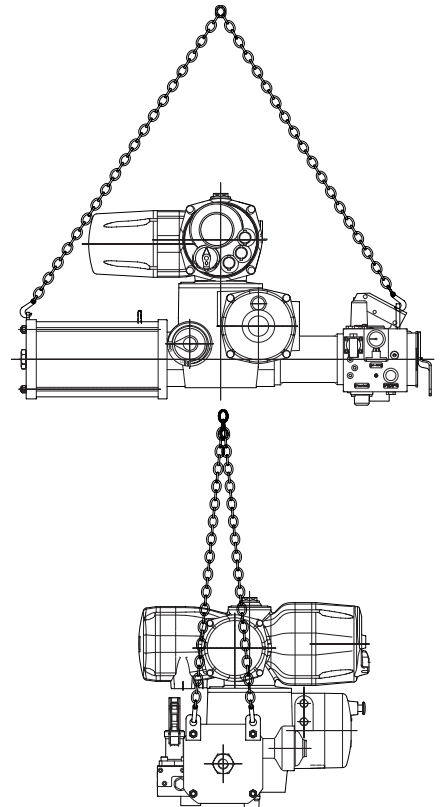

BIFFI FAIL SAFE ELECTRIC ACTUATORS, MODEL EFS2000V4

INSTRUCTION AND OPERATING MANUAL

- If the actuators are supplied separately from the valves, they must be placed onto a wooden pallet so as not to damage the coupling flange and the output shaft. In case of long-term storage, the coupling parts (flange, output shaft) must be coated with protective oil or grease; if possible, blank off the flange by a protection disk.
- In case of long-term storage, it is advisable to store the actuators in a dry place or to provide at least some means of weather protection. If possible, it is also advisable to periodically operate the actuators with filtered, dehydrated and lubricated air; after such operations, all the threaded connections of the actuator and the valves of the control panel (if present) should be carefully plugged.

4 ASSEMBLING THE ACTUATOR ONTO THE VALVE

The actuator is provided with an output flange (or a spool piece and a stem extension) as coupling to the valve. The assembly position of the actuator, with reference to the valve, must comply with the plant requirements (spring cartridge axis parallel or perpendicular to the pipeline axis).

4.1 Actuator supplied with insert already machined

To assemble the actuator onto the valve proceed as follows:

- Check that the coupling dimensions of the valve flange and stem, or of the relevant extension, meet the actuator coupling dimensions.
- Arrange the valve in the position related to the actuator spring operation.
- Lubricate the valve stem with oil or grease in order to make the assembly easier: be careful not to contaminate with lubricant the flange surfaces with have to be connected to transmit the actuator torque.
- Clean the valve flange and remove anything that might prevent a perfect adherence to the actuator flange and especially all traces of grease, since the torque is transmitted by friction.

- Assemble the stem extension onto the valve stem.
- Bring the actuator to the position caused by the spring operation.
- Connect a sling to the support points of the actuator and lift it: make sure the sling is suitable for the actuator weight. When possible, it is easier to assemble the actuator to the valve if the valve stem is in the vertical position. In this case the actuator must be lifted while keeping the flange in the horizontal position.
- Clean the actuator flange and remove anything that might prevent a perfect adherence to the valve flange and especially all traces of grease.
- Lower the actuator onto the valve so that the shaft output drive enters into the groove of the stem extension. This connection must take place without any force and only by the weight of the actuator. When the actuator output shaft and the valve stem are connected, check the holes of the valve flange. If they do not meet with the holes of the spool piece flange or the stud bolts screwed into them, the actuator shaft output drive must be rotated; feed the actuator cylinder with air at the proper pressure or actuate the manual override, until connection is possible.
- Assemble the insert into the EFS2000v4 as shown in the following pictures (the engraving realized on the insert has to correspond to the engraving present on the EFS2000v4 bush, as highlighted in the pictures).
- Tighten the nuts of the connecting stud bolts evenly with the torque prescribed in the table. If no different materials are specified, the stud bolts must be made of ASTM A 320 Grade L 7 steel, the nuts must be made of ASTM A 194 Grade 2 or better.
- If possible, operate the actuator to check that it moves the valve smoothly.

| Thread size | Recommended tightening torque (Nm) |
|-------------|------------------------------------|
| M6 | 8 |
| M8 | 20 |
| M10 | 40 |
| M12 | 70 |
| M14 | 110 |
| M16 | 160 |
| M20 | 320 |
| M22 | 420 |
| M24 | 550 |
| M27 | 800 |
| M30 | 1100 |

BIFFI FAIL SAFE ELECTRIC ACTUATORS, MODEL EFS2000V4

INSTRUCTION AND OPERATING MANUAL

5 ADJUSTMENT OF ANGULAR STROKE

It is important that the mechanical stops of the actuator (and not those of the valve) stop the angular stroke at both extreme valve positions (fully open and fully closed), except when this is required by the valve operation (e.g. metal seated butterfly valves).

The adjustment of the angular stroke is performed by adjusting the travel stop screw mounted on the spring cartridge end flange and the travel stop screw mounted on the EFS2000v4 housing (see the picture below).

For the adjustment of the stop screw proceed as follows:

- Loosen the lock nut.
- If the actuator angular stroke is stopped before reaching the end position (fully open or closed), adjust the stop screw by turning it counter clockwise until the valve reaches the right position. When unscrewing the stop screw, keep the lock nut still with a wrench so that the sealing washer does not withdraw together with the screw.

- Tighten the lock nut.
- If the actuator angular stroke is stopped beyond the end position (fully open or closed), adjust the stop screw by turning it clockwise until the valve reaches the right position.
- Tighten the lock nut.

WARNING!

The stop screw lock nut should never be removed from the actuator.

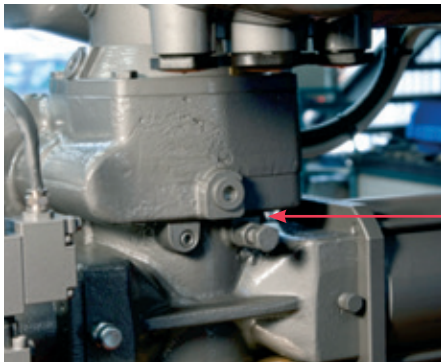

Position of the lock nut on the actuator housing



Adjusting the stop screw positioned on the actuator housing



Adjusting the stop screw positioned on the spring cartridge end flange

BIFFI FAIL SAFE ELECTRIC ACTUATORS, MODEL EFS2000V4

INSTRUCTION AND OPERATING MANUAL

6 INSTALLATION

6.1 Working condition

The standard EFS2000v4 are suitable for the following ambient temperatures:
 from -20°C to +70°C (from -22°F to +158°F) or
 from -45°C to +70°C (from -49°F to +158°F)

IMPORTANT

Check the "temperature ambient range" embossed on the nameplate, for the correct utilisation with respect to the ambient temperature.

Installation in ambient with temperature range outside the specified values will invalidate the warranty.

6.2 Removing the electrical enclosures covers

In the EFS2000v4 is foreseen the terminal enclosure shown in the following Picture. Using an Allen key, loosen the four screws fixing the cover and then remove it.

WARNING!

Pay attention to do not damage the joint surface of the covers.

IMPORTANT

In case the screws of the cover must be replaced, a SS AISI 316 Class A4 must be used with minimum yield strength of 450 N/mm².

6.3 Electrical connections

Before applying power to the EFS2000v4 check that the electrical parameters (supply voltage and current) shown on the nameplate and on the attached wiring diagram, are correct for the installation.

IMPORTANT

All the accessories required for the EFS2000v4, in particular the cable glands, must be certified according to the Standard Directive and specific rules, which apply for the specific application.

Remove the plugs from the cable entries.

For electrical connections use components (cable glands, cables, hoses, conduits) which meet the requirements and the applicable codes of the plant specifications (mechanical protection and/or explosionproof protection). Screw the cable glands (or the conduits) tightly into the threaded entries, in order to guarantee a weatherproof and explosionproof protection (when applicable).

Insert the connection cables into the electrical enclosure through the cable glands (or conduits) and connect the power supply, the control, the signal and ESD wires to the actuator, by linking them with the terminal blocks termination as per the wiring diagram. Replace the plastic plugs of the unused cable entries by metal ones, to guarantee perfect weatherproof tightness and to comply with the explosionproof protection codes (where applicable). Once the connections are completed, check that the controls and signals work properly.

6.4 Cable entries

The sealing of cable and conduit entry should be carried out in accordance with national standards or the regulatory authorities that have certified the EFS2000v4. This is particularly the case for units that are certified for use in hazardous areas where the method of sealing must be to an approved standard and cable glands, reducers, plugs and adapters must be approved and separately certified.

IMPORTANT

- To prevent water ingress through the cable conduits, verify that the cable glands used have the minimum degree of protection required by the plant.
- If rigid conduits are used, it is suggested to place a flexible pipe connection between the conduit and the terminal board.

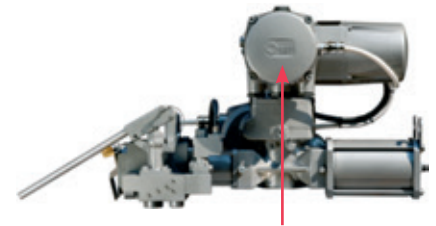

Main terminal enclosure for power and control wires

Remove the cable entry plug.

To guarantee weatherproof and explosionproof operation, screw the cable glands tightly (at least 5 turns) and block it with a thread sealant. The use of a thread sealant is necessary in case of explosionproof conditions.

If some parts of the cable glands have been removed during work on the cable entries put them back into place in order to avoid losing the dismantled parts.

Main terminal board

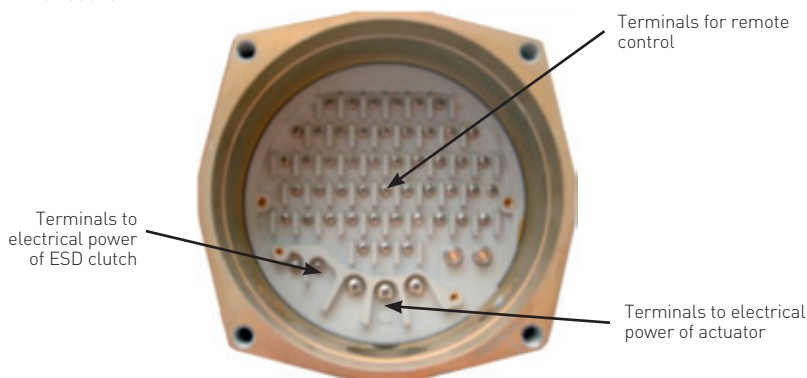

BIFFI FAIL SAFE ELECTRIC ACTUATORS, MODEL EFS2000V4

INSTRUCTION AND OPERATING MANUAL

6.4.1 Entries on the manually operated electrical switch enclosure

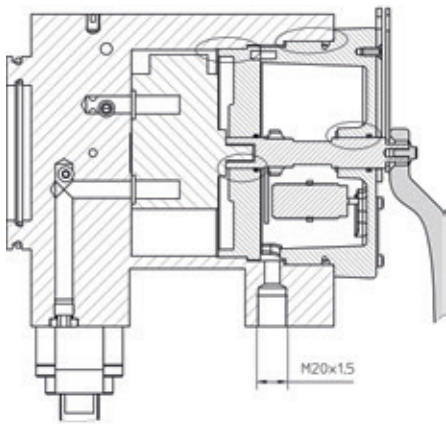

Procedure to be followed:

- Do not damage the explosion-proof mating surfaces on the housing and on the electrical enclosure covers.
- Reinstall all the screws that go with the dismantled parts, and block them with a thread sealant after spreading them with a film of copper- or molybdenum-based grease. This will keep screws from sticking and make maintenance operations easier.

IMPORTANT

In case the screws of the cover or other parts relevant to the explosion-proof protection must be replaced check that new bolts and/or screws are of the same dimension and quality as the original ones as stated on the list of material included on this manual, or of a better quality. In case the screws of the cover must be replaced, a SS AISI 316 Class A4 Grade 70 must be used with minimum yield strength of 450 N/mm².

6.4.2 Entries on the electro-magnetic clutch device enclosure

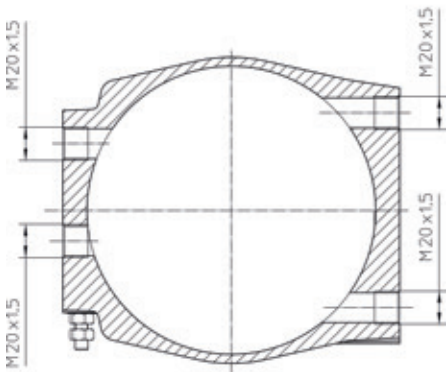

WARNING!

Do not electrically operate the EFS2000v4 when the electrical enclosures are removed. Operating the unit with the electrical enclosures removed could cause personal injury.

- Replace the weatherproof seals that may have been removed (O-ring for the covers, O-ring for the explosion-proof joint of the motor).

6.5.2 Installation in ambient temperature with explosive dusts

6.5 Safety instructions for installation in hazardous area

6.5.1 Instructions for the explosion-proof enclosures

IMPORTANT

Electric Actuator EFS2000v4 must be installed and maintained according to the applicable Rules regarding the electrical installation in Hazardous areas (other than mines) classified as zone 1 and/or 2 (gas) and zone 21 and/or 22 (dust) according to EN 60079-10 (hazardous area classification). Example: EN 60079-14 (electrical installation), EN 60079-17 (maintenance).

During the dismantling and subsequent reassembling of the explosion-proof enclosures (covers, cable glands, joints) be careful to bring these enclosures back to their original condition to maintain their integrity. In particular, be sure the joint surfaces of all enclosures are spread with a film of recommended grease.

IMPORTANT

Electric Actuator EFS2000v4 must be installed and maintained according to the applicable Rules regarding the electrical installation in Hazardous areas (other than mines) classified as zone 1 and/or 2 (gas) and zone 21 and/or 22 (dust) according to IEC/EN 60079-10 (hazardous area classification).

Example: IEC/EN 60079-14 (electrical installation), IEC/EN 60079-17 (maintenance).

Special attention must be paid to the following points:

- Before assembly, the joint surfaces must be greased with silicon oil or equivalent.
- The cable glands must have a protection degree at minimum IP66/68 (EN 60529).
- Periodically verify the layer of dust deposited on the enclosure and clean it in case the layer is more than 5 mm.

BIFFI FAIL SAFE ELECTRIC ACTUATORS, MODEL EFS2000V4

INSTRUCTION AND OPERATING MANUAL

7 EFS OPERATION

7.1 Operating the EFS 2000v4 for the first time

Before connecting electrical power to the actuator and ESD clutch, check that the voltages are correct. The ESD clutch can be operated by any voltage in the range of 24V DC-240V AC. The power to the actuator should be supplied according to the indication on the nameplate. Wrong power supply could cause permanent damage to the electrical components. Check of phase rotation is not necessary since the unit is provided with automatic phase rotation correction. Check that the valve is in SAFE POSITION and the manual override selector is in AUTO. Place the 3-position selector in OFF and apply power to the actuator and ESD clutch. The alphanumeric display of the actuator shows the following message for about 3 seconds: Then the new message should be:

| | | | |
|--------------------------------|-----|----|-------------|
| Biffi Italia EFS2000 v4 ntb | | | |
| INT EFS | OFF | or | INT EFS OFF |
| STOP | | | R%: xxx.x |

according to the configuration present in the memory. If the upper line of the display shows "ALARM", remove the alarm before proceeding (see chapters 'maintenance' and 'trouble-shooting'). If the upper line of the display shows "WARNING", a warning condition is present. You can continue if the EFS2000 is working okay, but some data is not according to the configured parameters (see chapters 'maintenance' and 'trouble-shooting'). If the upper line of the display shows "INT", an interlock input is active. If the upper line of the display shows "INT EFS", the clutch is not energized and the actuator cannot be electrically operated. If the upper line of the display shows "NORMAL" the actuator can be electrically operated.

Do not operate the actuator without first checking that the configuration is according to the required application by using the "VIEW and SET-UP" features (see chapters 'view menu', 'setup menu', 'view routines' and 'setup routines'). In particular the following parameters have to be set:

- ICON power-fail: enabled or disabled
- Selector in OFF: enabled or disabled
- Autoreset: enabled or disabled
- Reset delay: from 1 to 255 sec. The recommended value is greater than 1.5 times the maximum valve stroke time during EFS action.

The ESD clutch can not be energized until the manual override selector is in MANUAL. If AUTORESET was configured "enabled", wait until the LED in the clutch enclosure is green and the INT EFS message on the local display disappears. Place the local selector in LOCAL and electrically drive the actuator to open and close. If AUTORESET was configured "disabled", wait until the LED in the clutch enclosure is red and then push the red mushroom push button. When the above LED is green, the INT EFS message on local display disappears. Place the actuator local selector in LOCAL and electrically drive the actuator to open and close by means of the OPEN/YES and CLOSE/NO push button. Set torque limits and position limits by means of the "stroke limits routine" in the "actuator set-up" menu. When the stroke limits and the configurations are correct, move the 3-position selector to LOCAL and drive the actuator to either open or closed position. Move the 3-position selector to REMOTE, to remotely control the actuator.

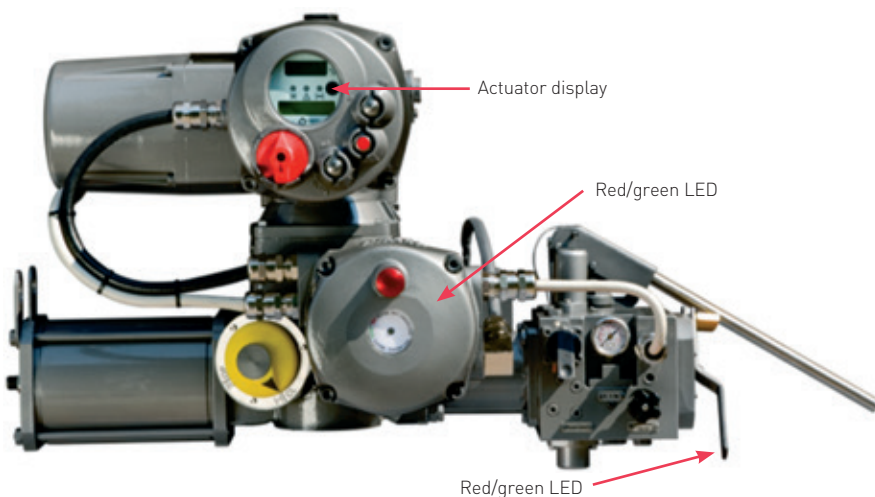

BIFFI FAIL SAFE ELECTRIC ACTUATORS, MODEL EFS2000V4

INSTRUCTION AND OPERATING MANUAL

7.2 ESD clutch status

A red/green LED on the clutch enclosure indicates the status of the ESD electrical clutch as follows:

- Off: Clutch not supplied
- Green: Clutch coil energized
- Red: Clutch coil not energized.
- Green flashing: Clutch coil will be energized at the end of the configured RESET DELAY time

7.3 Local Shut-Down operation, reset and autoreset

One red mushroom pushbutton is available as Local Shut-Down command and EFS reset. If clutch is energized, the LED in the clutch enclosure is green and the mushroom pushbutton works as Local Shut Down command to de-energize the coil clutch and perform the action operated by the spring. If clutch is not energized, the above LED is red and the mushroom pushbutton works as EFS reset, to energize the clutch coil and allow electrical open/close operation. AUTORESET function works only if it was configured "enabled". The above function performs an automatic EFS reset and energizes the clutch coil after the configured RESET DELAY time. The configured RESET DELAY time must be greater than the stroke time during Local Shut-Down operation.

7.4 EFS Shut-Down action

The EFS ESD action is carried out in case of loss of voltage supply of clutch coil (as it's described in SM 020 (SIL Safety Manual – Actuator series EFS2000 v4)

The Local Shut-Down actions are carried out if the Local red mushroom pushbutton is pressed

According to actuator configuration, the EFS action can be carried out also in case of:

- loss of actuator main power supply
- 3-position selector in OFF: the start of EFS action is delayed 20 sec from switching to OFF of the selector to allow the operator to enter view and setup mode. In VIEW and SETUP mode the Shut-Down action is not carried out.

The condition EFS action in progress can be configured to switch-over the monitor relay for remote signalling by means of VIEW and SETUP menu ("ESD – EFS" parameter). If SAFE POSITION is not reached after a predetermined time, an alarm of EFS MID TRAVEL is generated. The alarm is locally indicated by the yellow LED of the actuator and remotely by the change over of the monitor relay and one of the auxiliary relay As1,...,As8, according to the configuration done in the VIEW and SETUP menu.

After the EFS action has been carried out, the local display shows the message "INT EFS" and actuator electrical commands are inhibited. If AUTORESET function is ON (enabled), the EFS reset is performed after the RESET DELAY time and the electrical actuator commands are available. If the AUTORESET function is OFF (disabled) it needs to push the red mushroom pushbutton to perform EFS reset and enable electrical actuator commands.

During the Shut-Down action the time corresponding to 1% of position change is memorized. Up to 16 Shut-Down action profiles can be memorized. When a new set of data is available the oldest one is cancelled and the new set is stored. The command "SET ESD REFERENCE" (to be intended as "Set EFS Shut-Down Reference") available in the VIEW and SETUP menu allows to make a copy of 1 off 16 "ESD curves" in the "ESD reference". The "Shut-Down reference" will not be updated until a new "SET ESD REFERENCE" (to be intended as "Set EFS Shut-Down Reference") command is entered. Via Bluetooth, the data can be read by a PDA or PC with A-manager tool and the Shut Down curves and reference, Position versus Time, can be visualized and compared.

Note: In this case, ESD is simply a firmware parameter related to a Shut-Down action which is not related to the EFS 2000v4 "safety function".

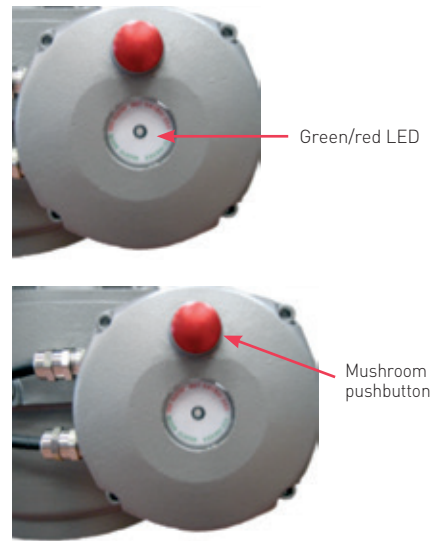

7.5 Manual override operation

The AUTO/MANUAL selector allows selecting between MANUAL and AUTO mode. In MANUAL mode the ESD clutch is de-energized, the actuator remains in its current position, electrical commands are inhibited, the LED in the clutch enclosure is red, the message on the actuator display is INT EFS and the actuator can be manually moved by means of the hand pump and the hand operated spring return valve (hydraulic control group). To re-energize the clutch and be ready to perform the EFS action, press the red mushroom push button for 10 seconds and then switch the AUTO/MANUAL selector to AUTO within 30 seconds to enable AUTO mode. The actuator remains in its current position and is available to be driven by electrical commands. If the selector remains in MANUAL mode during 30 seconds, the clutch is de-energized again. If the selector is switched to AUTO without performing the above procedure, the actuator carries out the ESD action since the clutch is not energized.

The condition EFS in MANUAL can be configured to activate the monitor relay by means of VIEW and SETUP menu ("output relays, ESD - EFS" parameter). The above condition can also be signaled by an auxiliary relay As1, ..., As8 by configuring the parameter "EFS in manual" in the VIEW and SETUP features: Output relays.

In AUTO mode the EFS is controlled by the electrical actuator as described in previous paragraphs.

7.6 Partial stroke test (PST)

The PST function is available to check the functionality of the essential parts and to achieve the EFS safety function while the valve is in line and in service. The test consists in de-energizing the clutch to move the valve to the configured position (PST TRAVEL) by action of spring and then re-energizing the clutch to stop the valve moving. After the PAUSE time the valve is moved to initial position by the actuator.

The following parameters are available in the VIEW and SETUP menu, ACTUATOR SETUP, EFS SETUP, PST SETUP routine, to set PST function behaviour:

1. PST mode: OFF, AUTO, MANUAL
 - OFF: PST not used
 - AUTO: PST cycle carried out automatically and cyclically with time interval set by the parameter PERIOD and at the time set by the parameter HOUR of DAY
 - MANUAL: PST cycle carried out on receiving of a remote hardwired or bus command or by a local command available in the VIEW and SETUP menu, Maintenance functions.
 - MAN-AUTO: both automatic and manual mode are available
2. SPRING action: spring to open or spring to close
3. PERIOD: time interval between PST, in days from 0 to 1000, in PST AUTO mode
4. HOUR of DAY: hour of PST, in hour from 0 to 23, in PST AUTO mode.
5. PST TRAVEL: position change during PST cycle, in % of position from 10 to 40
6. MAX T-PST: max time allowed to change the position of PST TRAVEL due to spring action, measured in %, from 1 to 1000% of relevant BASELINE time
7. MAX PST T-RET: max time to return to initial position by the electrical actuator, measured in %, from 1 to 1000% of relevant BASELINE time
8. PAUSE: time of stayput of actuator after spring action and before command to return to initial position, measured in sec, from 2 to 255 sec.
9. MAX PST OV-TR: max position over-travel allowed during PST cycle, in percentage of position, from 1 to 100.

The following figure shows the PST curve for EFS with close safe position:

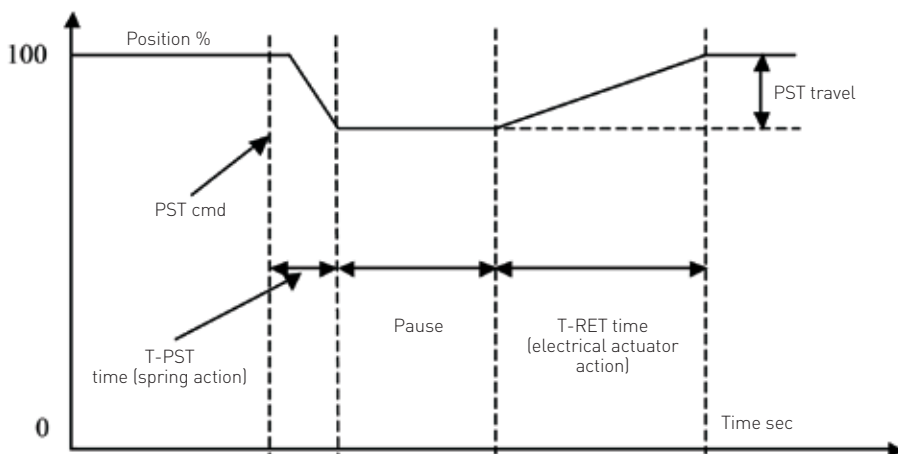
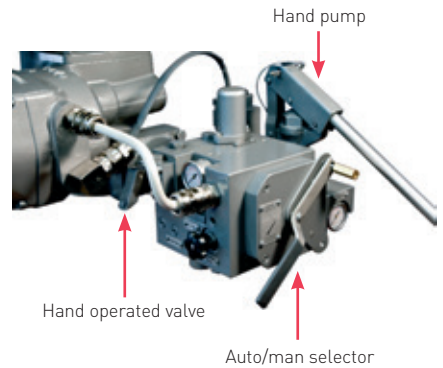

BIFFI FAIL SAFE ELECTRIC ACTUATORS, MODEL EFS2000V4

INSTRUCTION AND OPERATING MANUAL

7.6.1 Command to initiate PST cycle

The PST cycle is initiated only if the actuator is in the correct end of travel (fully open with spring to close or fully close with spring to open). In PST AUTO mode, the test is performed at a configurable period of time and hour of the day (according to the configured parameters) if the actuator local selector is in LOCAL or REMOTE.

In PST MANUAL mode, the test is performed when a remote hardwired or bus command is received and if the actuator local selector is in REMOTE. The test can be also be executed by a local command available in the VIEW and SETUP menu, SETUP, MAINTENANCE routines, PST command.

Select option "new baseline" to save the collected data in the BASELINE curve, select option "normal" to save the data as a normal PST curve.

In PST MAN-AUTO, the test is performed automatically and by a local or remote command according to above description.

7.6.2 Reset of PST cycle

The PST cycle aborts on the following condition:

- Actuator local selector switched during PST execution.
- EFS action during PST execution
- Switch of manual override selector to MANUAL.
- Failure of solenoid valve used to perform PST cycle
- Alarm of electrical actuator.
- Position does not change in a predetermined time during the spring action phase

7.6.3 PST report and warning

At the end of each PST cycle, the following status and warnings are available:

- Passed: test OK.
- Reset: test aborted. The warning "PST" is generated.
- T-PST: failed time T-PST, time needed to change the position of the PST TRAVEL by the spring action. The warning "T-PST" is generated.
- T-RET: failed time T-RET, time to return to position before test. The warning "T-PST" is generated.
- OV-TR: PST over-travel, the position change was greater than allowed. The warning "OV-TR" is generated.
- Failed: at least two of the T-PST, T-RET, OV-TR conditions failed. The warning "Failed" is generated.

The data can be viewed by the local operator interface or by a PC/PDA connected via Bluetooth interface. Warnings are recorded in the warning log registers (see maintenance routines of VIEW and SETUP menu).

7.6.4 PST curves and PST baseline

During the PST cycle the time corresponding to any 1% of valve position variation is memorized. With the above data it is possible to view the curve of the "valve position%" versus "time". Up to 16 PST curves can be memorized. When a new set of data is available the oldest one is deleted and the new data is stored. The command "SET PST REFERENCE" available in the VIEW and SETUP menu allows one to make a copy of 1 of the 16 "PST curves" to the "PST BASELINE". The "PST BASELINE" will not be updated until a new "SET PST BASELINE" command is entered.

The BASELINE curve can also be defined by the PST command, available in the VIEW and SETUP menu, SETUP, MAINTENANCE routines. By selecting the option "BASELINE" the PST command is executed and the collected data are saved in the PST BASELINE.

The data can be read by a PDA or PC with the A-manager software and PST curves and BASELINE, position versus time, can be visualized and compared.

7.7 Remote signaling

The parameter "ESD" (to be intended as "EFS Shut-Down Reference") , in the VIEW and SETUP menu, Actuator setup, Output Relays, can be used to configure the monitor relay to switch over if the following conditions occur:

- Clutch de-energized and AUTO/MANUAL selector in AUTO. It means that the EFS action is in progress
- AUTO/MANUAL selector in MANUAL. It means that EFS is not available

The following conditions can be individually configured to switch the auxiliary relays As1,...,As8.

- PST active: PST cycle in progress
- EFS in MANUAL: manual override active
- EFS mid travel alarm: FAILSAFE position not reached in the predetermined time
- PST failed: it summarizes the conditions T-PST, T-RET, OV-TR, PST reset . The status of relay can be reset by a manual reset via actuator local operator interface or alternatively by a new PST command.

7.8 EFS local report

By the VIEW and SETUP menu of the local operator interface, the status of the EFS module can be viewed (see chapter 'Local controls', 'EFS report'). The following data are available:

- EFS card code
- EFS card manufacturing week and year
- EFS status: ready, not ready
- Base-EFS error counter
- Coil of clutch status: ON, OFF
- Manual override selector status: AUTO, MANUAL
- Last PST result: passed, reset, failed, OV-TR (over-travel failed), T-PST (time of spring action failed), T-RET (time of return to initial position failed)
- Next PST: date of next PST cycle, in AUTO PST mode
- Temperature: °C
- Mushroom push button status: ON, OFF
- Heater status: ON, OFF
- T-PST: (T-PST-baseline), last-T-PST, in sec
- T-RET: (T-RET-baseline), last-T-RET, in sec
- OV-TR: (OV-TR-baseline), last-OV-TR, in % of opening

7.9 Entering the VIEW and SETUP menu mode

If the option "SELECTOR in OFF: disabled" is configured, move the selector to OFF and then press simultaneously OPEN/YES and STOP push buttons to enter in the VIEW and SETUP menu.

If the option "SELECTOR in OFF: enabled" is configured, move the selector to OFF and within 20 sec, press simultaneously OPEN/YES and STOP push buttons to enter in the VIEW and SETUP menu. If VIEW and SETUP operation are not entered a new ESD action will be carried out.

It is possible to enter in VIEW and SETUP menu after the ESD action has been carried out, but the actuator cannot be operated electrically.

8 ACTUATOR OPERATION

8.1 Actuator local controls

For EFS "standard" version
 After configuring the actuator, if no alarm is present, place the 3-position selector in LOCAL and control the actuator by OPEN, CLOSE and STOP push-buttons. If "push-to-run" was selected the actuator can be driven to the desired position by pressing and holding the OPEN/YES or CLOSE push-button. As the push-button is released, the motor is de-energized. If "latched" was selected, as the OPEN or CLOSE push-button is pressed the motor is energized, and it runs on also after the push-button is released. To stop the motor, press the STOP push-button. To reverse the direction, press the STOP push-button and then press the push-button relevant to the opposite direction. In "latched with instant reverse" mode, the local controls work as in the "latched" mode, but to reverse the motor direction you only need to press the push-button relevant to the opposite direction.

8.2 Local indication

The upper display indicates the valve position as a percentage of opening (open = 100%). The lower display has two alphanumeric lines. The upper line indicates the actuator status and the 3-position selector status. The lower line indicates the actuator operation, or the position request percentage value, according to the configuration. Two LED's indicate the actuator position/operation, while a third LED indicates alarms.

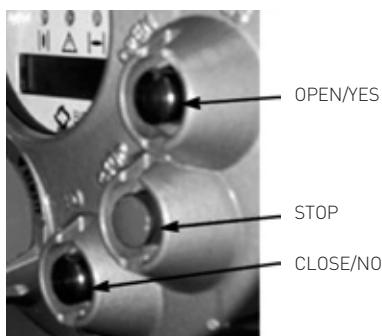

BIFFI FAIL SAFE ELECTRIC ACTUATORS, MODEL EFS2000V4

INSTRUCTION AND OPERATING MANUAL

8.3 Locking the 3-position selector

The 3-position selector can be locked in any of its three positions by means of a padlock.

8.4 Remote control

Place the 3-position selector in REMOTE to transfer the actuator control to a remote control system. Local OPEN or CLOSE operation will be inhibited. Only the local STOP control remains active. Using the "VIEW and SET-UP" features may configure different control modes. The remote controls are opto-coupled. A non-regulated 24V DC voltage (variable from 23 to 27V DC, max. 4W) is available on the actuator terminal board to supply the remote controls or external devices.

8.4.1 Remote commands

For EFS standard version

Using the "VIEW and SET-UP" features may configure different control modes.

Four wires (see the remote connections diagram shown).

In "4 wires latched" (OPEN, CLOSE, STOP, COMMON) mode, with the OPEN or CLOSE signal switched to ON, the motor is energized, and it continues to run after the signal returns to OFF. To stop the motor, press STOP. To reverse the direction, press STOP and then press the button relevant to the opposite direction. The action of the STOP signal (stop with signal ON or stop with signal OFF) may be reversed using the VIEW and SET-UP features, see chapter 'set-up routines, paragraph 'remote controls'.

Three wires (see the remote connections diagram shown).

With option "3 wires" (OPEN, CLOSE, COMMON), the actuator can be driven in either "push-to-run" or "latched with instant reverse" mode. In "push-to-run" mode, the actuator can be driven to the desired position by switching the OPEN or CLOSE signal to ON. As the signal returns to OFF, the motor is de-energized. In "latched with instant reverse" mode, when the OPEN or CLOSE signal switches to ON, the motor is energized, and it continues to run after the signal returns to OFF. If the signal relevant to the opposite direction is activated, the actuator reverses its direction and maintains the new direction also if the signal returns to OFF.

Two wires (see the remote connections diagram shown).

With the "2 wires" option, 2 different activities may be selected: In "2 wires, signal ON to open", the actuator opens if the signal switches to ON and closes if the signal goes to OFF. In "2 wires, signal ON to close", the actuator closes if the signal switches to ON and opens if the signal switches to OFF. This option requires two wires (signal and common).

The circuits associated to the inputs are opto-coupled and be supplied by the internally generated 24V DC or by an external 20-125V DC or 20-120V AC (50/60Hz) power supply. The signal levels are the following:

- Minimum ON signal > 20V DC or 20V AC (50/60Hz)
- Maximum ON signal < 125V DC or 120V AC (50/60Hz)
- Maximum OFF signal < 3V
- Minimum signal duration > 500 ms.
- Total current drawn from remote controls < 25 mA



Four wires (INT/EXT powered)

Option A1)

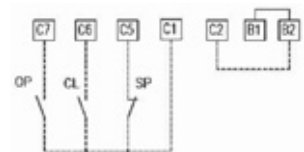

Option B1)

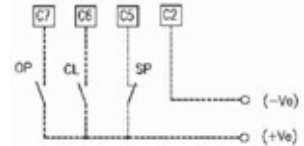

Three wires (INT/EXT powered)

Option A2)

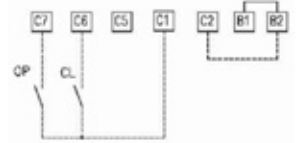

Option B2)

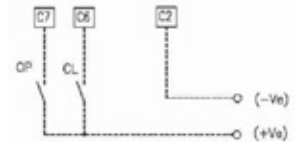

Two wires (INT/EXT powered)

Option A3)

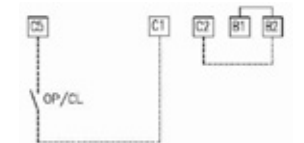

Option B3)

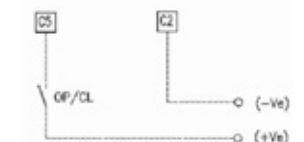

BIFFI FAIL SAFE ELECTRIC ACTUATORS, MODEL EFS2000V4

INSTRUCTION AND OPERATING MANUAL

8.4.2 Output contacts

Standard version:

- Monitor relay: on the terminal board, a single voltage-free, change-over contact of the monitor relay is available. The monitor relay indicates that the actuator can be remotely controlled or that there is a problem or condition which prevents remote control of the valve. The conditions that cause the relay to switch over are listed in chapter 'Set-up routines' paragraph 'Output relays'.
- AS1, 2, 3, 4, 5, 6, 7 relays: on the terminal board, 7 voltage-free contacts of 7 latching relays are available. The status (make or break) and the conditions that cause the switching of the relay can be viewed and configured by using the "VIEW and SET-UP" features. The status of the latching relays is immediately updated as the associated conditions for change occur.
- AS8 relay: a further voltage-free, change-over contact is available on the terminal board. The conditions that cause the switching of the relay can be viewed and configured by using the "VIEW and SET-UP" features.
- Contact rating: max. voltage 250V AC/30V DC; max. current 5A; min. voltage 5V DC; min. current 5 mA.

A special version with highly sensitive golden plate contact relays can be supplied on request:

- Monitor relay: voltage-free, change-over, gold-cap silver palladium contacts.
- AS1, 2, 3 relays: voltage-free, change-over, latching, gold-cap silver palladium contacts.
- AS4 relay: voltage-free, latching, gold-cap silver palladium contacts, configurable N.O or N.C in the 'Set-up routines', 'Output relays' menu.
- AS5, 6 relays: voltage-free, change-over, gold-cap silver palladium contacts.
- The condition that cause the switch-over of the monitor relay and auxiliary relays AS1, ..., AS6 are the same as the standard version and are configurable in the 'Output relays' menu.
- AS7, 8 relays: not available.
- Contact rating: max. voltage 250V AC; max. current 2A; min. switching capability 10microA, 10mV DC.

8.4.3 Input PST/EFS

The PST input is available as remote command to initiate the PST cycle. PST is activated when signal in PST input is present. The "VIEW and SET-UP" features, chap SET-UP ROUTINES, par. EFS SETUP, can configure the characteristic of PST function.

The PST/EFS input is opto-coupled. The circuits associated to the input can be supplied by the internally generated 24V DC or by an external 20-125V DC or 20-120V AC [50/60Hz] power supply. The signal levels are the following:

- Minimum ON signal > 20V DC or 20V AC [50/60Hz]
- Maximum ON signal < 125V DC or 120V AC [50/60Hz]
- Maximum OFF signal < 3V
- Current drawn from ESD controls < 15 mA
- Min signal duration: 1 sec

8.4.4 Interlock inputs

Two additional inputs are available to inhibit actuator movement in open or close direction. The controls are momentary, and the inhibit action continues until the relevant signal is present. The interlock controls work when the Local Selector is in either LOCAL or REMOTE positions. The "VIEW and SET-UP" features can configure the polarity of INTERLOCK signal as described in chapter 'Set-up routines', paragraph 'interlock controls'.

The interlock inputs are opto-coupled and can be supplied by the internally generated 24V DC or by an external 20-125V DC or 20-120V AC [50/60Hz] power supply.

The signal levels are the following:

- Minimum ON signal > 20V DC or 20V AC [50/60Hz]
- Maximum ON signal < 125V DC or 120V AC [50/60Hz]
- Maximum OFF signal < 3
- Total current drawn from remote controls < 20 mA

Place the 3-position selector in REMOTE to transfer the actuator control to a remote device. Local OPEN or CLOSE operation will be inhibited. Only local STOP control remains active. Using the "VIEW and SET-UP" features may configure different control modes. The remote controls are opto-coupled. A non-regulated 24VDC voltage (variable from 23 to 27 Vdc, max. 4W) is available on the actuator terminal board to supply the remote controls or external devices.

PST (INT/EXT powered)

Option D1)

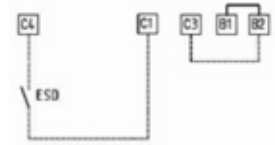

Option D2)

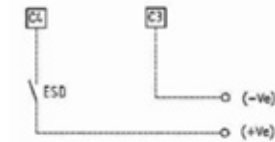

Interlock (INT/EXT powered)

Option E1)

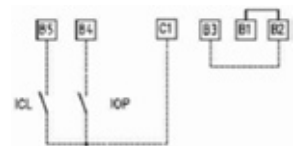

Option E2)

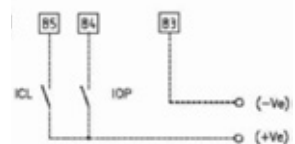

9 OPTIONAL MODULES

Additional modules can be plugged in the base card of the ICON2000 to provide the following functions:

9.1 Fieldbus interface for remote control via Fieldbus

This card allows to connect the ICON2000 to Fieldbus. The following bus interface cards are available:

- Profibus DPV0
- Profibus DPV1 with or without redundancy
- Foundation Fieldbus
- LonWorks
- Modbus RTU
- Hart

A hardware alarm is generated if the EFS2000 was set to be equipped with BUS card, but the card is damaged or missing. A BUS REPORT is also present in the list of reports if the card is present (see chapter 'Local controls', paragraph 'Description of variables and reports'). See the specific manuals for instructions and the setting of the above modules.

9.2 AIN/AOUT card

With the above card the ICON2000 is provided with a 4-20 mA analog input and a 4-20 mA analog output. This card should be plugged on the base card, replacing the "TERMINAL BOARD ADAPTOR" card supplied as standard. A hardware alarm is generated if the ICON2000 was set to be equipped with an Ain/Aout card, and the card is damaged or missing. An Ain/Aout REPORT is also present in the list of reports if the card is present (see chapter 'Local controls', paragraph 'Description of variables and reports').

9.2.1 The 4-20 mA analog output

The 4-20 Ma output can be configured to provide a signal proportional to either 'position' or 'torque'. The polarity option allows to reverse the relationship between the position or torque and the 4-20 mA output signal. See "VIEW and SET-UP" features (chapter 'Set-up routines', paragraph 'OUT 4-20 mA').

The 4-20 mA output is opto-coupled. It should be powered by a 20-30 V DC voltage (externally or internally generated) and the maximum load, including the cable resistance, should be less than 300 Ohm.

The behavior in case of loss of main voltage is different if the power supply of the 4-20 mA output stage is internally or externally generated:

- Internal power supply (or passive loop): in case of loss of main voltage the output 4-20 mA drops to 0. The correct output will be restored when the main voltage returns.
- External power supply (or active loop): if the actuator is provided with a lithium battery (or supplied by the auxiliary 24V DC) and if the main voltage fails, the output 4-20 mA maintains the last value. If the actuator is moved by handwheel, the output 4-20 mA will be updated. If the actuator is not provided with a lithium battery (or not supplied by the auxiliary 24V DC) and if the main voltage fails, the output 4-20 mA maintains the last value. If the actuator is moved by handwheel, the output 4-20 mA will not be updated.

The figure below shows the wiring diagram:

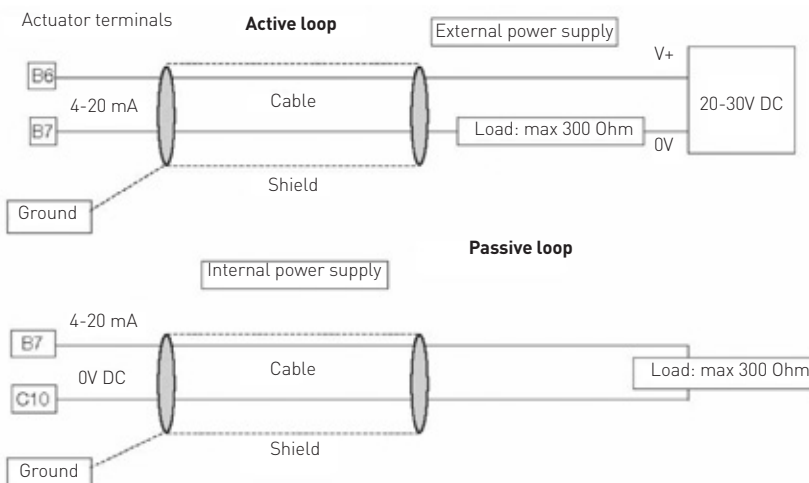

BIFFI FAIL SAFE ELECTRIC ACTUATORS, MODEL EFS2000V4

INSTRUCTION AND OPERATING MANUAL

9.2.2 The 4-20 mA analog input

The 4-20 mA analog input is the position request R% signal and is used by the ICON2000 to position the valve in any position between 0 and 100% of the full stroke. The 'POSITIONER' routine processes the input signal, compares the present actuator position % with the position request R% and if the difference is greater than the dead band, the actuator is driven to reach the requested position. 4 mA corresponds to request R% = 0% = valve closed and 20 mA corresponds to request R% = 100% = valve open. The relationship between position and request signals can be reversed by the 'Polarity' function. The 4-20 mA input is opto-coupled. The input impedance is less than 250 Ohm. The loss of the 4-20 mA input signal is indicated as followed:

- Change-over of the monitor relay
- Alarm LED on
- List of ALARMS (see 'Maintenance' and 'Troubleshooting', 'Diagnostic messages')
- Alarm log

The figure below shows the wiring diagram:

The "VIEW and SET-UP" features can configure different options which are described in chapter 'Set-up routines', paragraph 'Positioner'.

If the POSITIONER function is active the alpha-numeric display indicates the value of the position request in % (R%: xxx.x).

9.3 Bluetooth card

The ICON2000 can be provided with a radiofrequency wireless connection based on a qualified Bluetooth™ class 1 module. This allows the actuator to establish a connection and exchange data with a PDA or PC with built-in Bluetooth™ technology. Special PDA's are available for application in hazardous areas. The following tasks can be performed wirelessly:

- View and change configuration
 - Set maintenance function
 - Read maintenance data
 - Download new firmware to the ICON2000
- A WIRELESS REPORT is present in the list of reports when the card is present (see chapter "Local controls", 'Description of variables and reports').

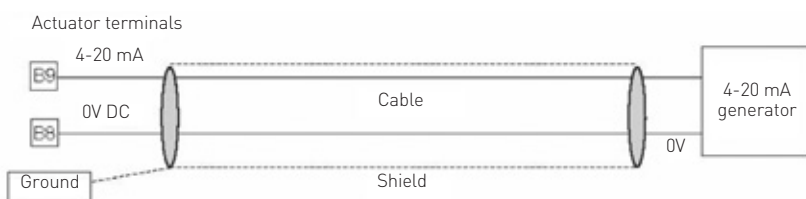
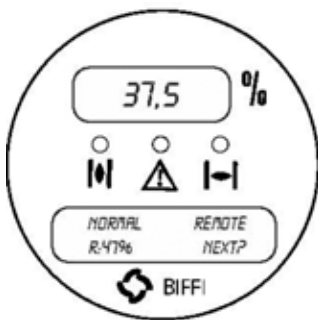

BIFFI FAIL SAFE ELECTRIC ACTUATORS, MODEL EFS2000V4

INSTRUCTION AND OPERATING MANUAL

9.4 Base card of EFS 2000v4

The following figures show the 'base card' of cards of EFS 2000 and its different option cards.

Base card of the EFS 2000v4

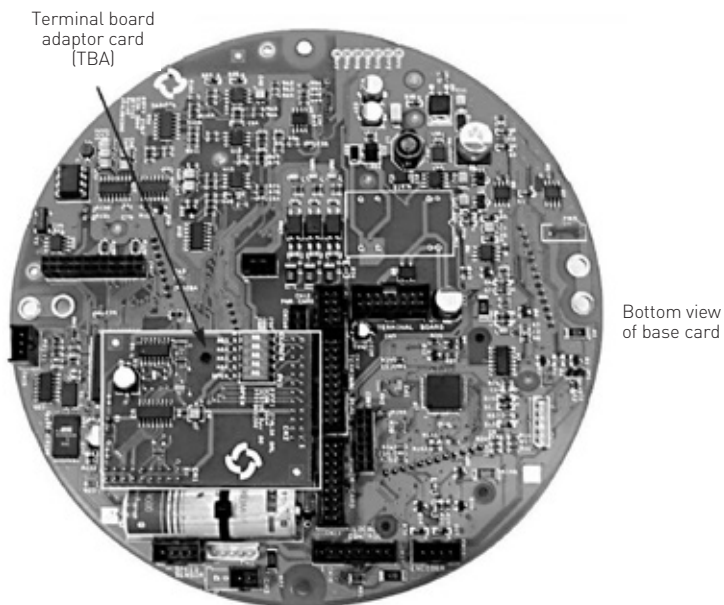

AIN/AOUT card

This optional card is used instead of the Terminal Board Adaptor (TBA) card when an analog 4-20 mA input and output signal is requested.



Fieldbus interface card



BIFFI FAIL SAFE ELECTRIC ACTUATORS, MODEL EFS2000V4

INSTRUCTION AND OPERATING MANUAL

The type of card depends on the fieldbus available in the plant.

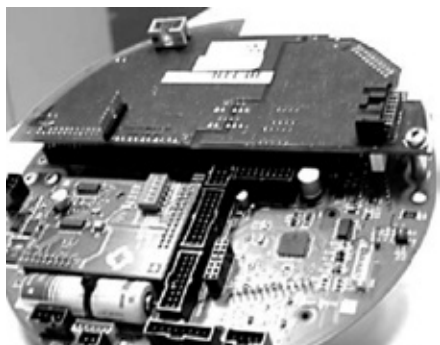

Top view of base card equipped with Fieldbus Interface

Bluetooth™ card



Potentiometer /4-20 mA position card

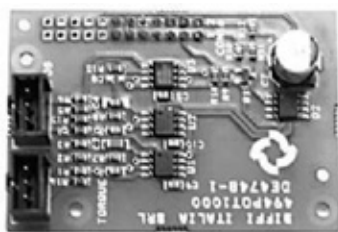

Potentiometer /4-20 mA card: with this card properly set through the VIEW and SET-UP menu, the base card reads the position from a potentiometer or from a 4-20 mA transmitter.

BIFFI FAIL SAFE ELECTRIC ACTUATORS, MODEL EFS2000V4

INSTRUCTION AND OPERATING MANUAL

10 LOCAL CONTROLS

10.1 Description of the local operator interface

The following functions are available by the EFS2000v4 local operator interface:

- Actuator control
- Actuator configuration
- Actuator status visualisation
- EFS action control

The figures on the following pages describe the function of each component of the local operator interface

10.2 Local operator interface

Numeric display to indicate the present valve position as a percentage of the opening. Display resolution 0.1%.

Three LED's to indicate the actuator status according to the following logic:

- green ON/red OFF: the actuator is stopped in open position
- green OFF/red ON: the actuator is stopped in closed position
- green OFF/red flashing: the actuator is running in closing direction
- green flashing/red OFF: the actuator is running in opening direction
- green ON/red ON: the actuator is stopped in intermediate position
- yellow ON: alarm
- yellow flashing: warning

The above color combination is supplied as standard, but it may be changed (red with green, green with red, and yellow with red), during actuator setting operations.

Local controls: OPEN/YES, CLOSE/NO, and STOP push buttons.

The STOP push button resets any existing command and is active both in local and remote.

If the 3-position selector is in LOCAL, the OPEN/YES, and CLOSE/NO push buttons work as OPEN and CLOSE commands.

If the 3-position selector is in REMOTE or in OFF, the OPEN/YES and CLOSE/NO push buttons work as YES and NO to answer the prompt (next? OK? view? change? exit?) of the alphanumeric display.

In OFF, the OPEN/YES and CLOSE/NO push buttons allow to scroll down the menu, to view and change the actuator configuration or to scroll the list of variables, status and alarms. In REMOTE, the above push buttons allow scrolling through the list of variables, status, alarms and reports, but the actuator configuration cannot be viewed or changed.

Alphanumeric display: during normal operation the alphanumeric display shows the present status (NORMAL, INT EFS, ALARM, WARNING, INTERLOCK), the 3-position selector status (LOCAL, OFF, REMOTE) and the actuator action (OPEN, OPENING, CLOSED, CLOSING, STOP or R%: xxx.x). If the local selector is in OFF or REMOTE, pressing the YES push button it is possible to scroll through the list of variables, alarms and reports:

- Output torque
- Motor speed
- Main voltage
- Current
- Temperature
- Mot temp
- Term temp
- Log status
- Wireless report
- Node report*

- Time
- Date
- Alarm
- Warning
- Ktemp
- FDI report*
- Base report
- Term report
- Ain/Aout report*
- EFS report

The data with * are only present if the relevant modules are present.

3-position selector to set the following operation modes:

- LOCAL: for local control only
- OFF: no control is active but the actuator is still connected to the mains
- REMOTE: for remote control only

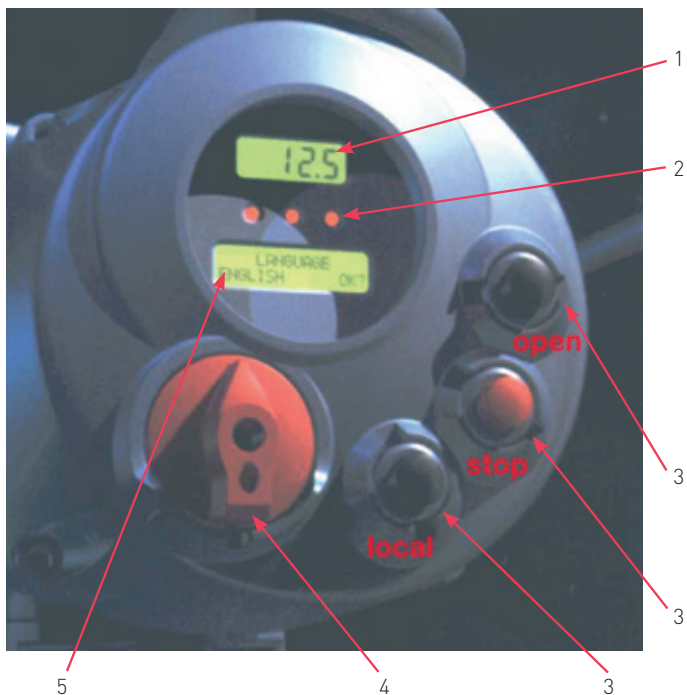

PARTS LIST

| Item | Description |
|------|----------------------|
| 1 | Numeric display |
| 2 | Three LED's |
| 3 | Local controls |
| 4 | 3-position selector |
| 5 | Alphanumeric display |

BIFFI FAIL SAFE ELECTRIC ACTUATORS, MODEL EFS2000V4

INSTRUCTION AND OPERATING MANUAL

10.3 Description of variables and reports

| | |
|---|--|
| <input type="checkbox"/> Torque: | Output torque in % of the nominal torque stated in the NAMEPLATE menu |
| <input type="checkbox"/> Motor speed: | RPM of electrical motor |
| <input type="checkbox"/> Main voltage: | Voltage (V) and frequency (Hz) of mains |
| <input type="checkbox"/> Current: | Current (A) absorbed by the motor |
| <input type="checkbox"/> Temperature: | Temperature (°C), inside the electronic compartment |
| <input type="checkbox"/> Time: | Present time |
| <input type="checkbox"/> Date: | Present date |
| <input type="checkbox"/> Alarm: | List of present alarms (see chapter 'Maintenance' and 'Troubleshooting') |
| <input type="checkbox"/> Warning: | List of present warnings (see chapter 'Maintenance' and 'Troubleshooting') |
| <input type="checkbox"/> Ktemp: | Temperature factor |
| <input type="checkbox"/> Mot temp: | Temperature (°C) of the electrical motor |
| <input type="checkbox"/> Term temp: | Temperature (°C) inside the terminal board compartment |
| <input type="checkbox"/> Log status: | Data logger status (off, ready, in progress: E: event number - n° of memory cycle or R: sample number - n° of memory cycle) |
| <input type="checkbox"/> Wireless report: | Bluetooth™ interface status (available, not available) |
| <input type="checkbox"/> Node report: | Report of BUS interface card (only present if the bus card is present) (see the relevant instruction manual) |
| <input type="checkbox"/> FDI report: | Report of FDI function (only present if the LonWorks bus card is present) (see the relevant instruction manual) |
| <input type="checkbox"/> Base report: | Base card report <ul style="list-style-type: none"> • Card code • Manufacturing week and year • Electrical diagram, etc |
| <input type="checkbox"/> Term report: | Terminal board card report <ul style="list-style-type: none"> • Card code • Manufacturing week and year • Electrical diagram, etc |
| <input type="checkbox"/> Ain/aout report: | Ain/Aout card report (only present if the card is present) <ul style="list-style-type: none"> • Card code • Manufacturing week and year • Electrical diagram, etc. |
| <input type="checkbox"/> EFS report: | EFS card report <ul style="list-style-type: none"> • Card code • Manufacturing week and year • Electrical diagram, etc • EFS status: ready, not ready • Base-EFS error counter • Coil of clutch: ON,OFF • Manual switch: AUTO, MANUAL • Last PST result: passed, reset, failed, OV-TR, T-PST, T-RET • Next PST: date • Temperature: °C • Mushroom push button: ON, OFF • Heater: ON, OFF • T-PST: (T-PST-baseline), last-T-PST, in sec • T-RET: (T-RET-baseline), last-T-RET, in sec • OV-TR: (OV-TR-baseline), last-OV-TR, in % of opening |

The warning condition occurs when a variable reaches a critical value and/or a maintenance action is required, but the actuator control functions are still available. The alarm condition occurs when a variable is out of the acceptable range and the actuator control functions are not available. The alarm and warning lists only contain the present alarms and warnings. When the fault condition disappears, the corresponding alarm or warning disappears from the list. A reset routine is provided to clear the type of alarm/warning that are memorized (overtorque, jammed valve, etc.).

The following drawing shows the use of the OPEN/YES, CLOSE/NO and STOP push buttons in function of the local selector position.

BIFFI FAIL SAFE ELECTRIC ACTUATORS, MODEL EFS2000V4

INSTRUCTION AND OPERATING MANUAL

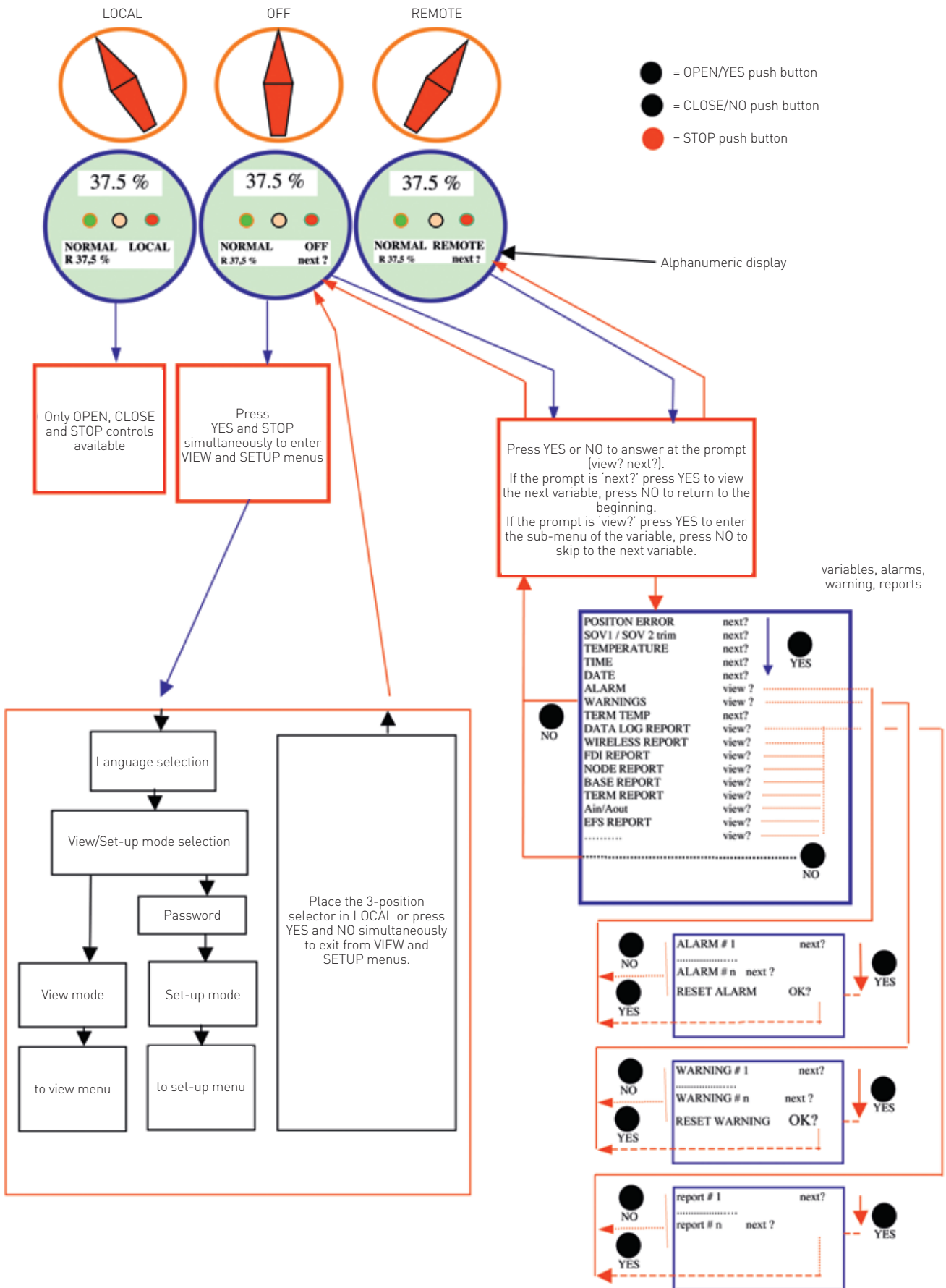

BIFFI FAIL SAFE ELECTRIC ACTUATORS, MODEL EFS2000V4

INSTRUCTION AND OPERATING MANUAL

10.4 Configuration options

The EFS2000 actuator can be totally configured from the local interface by means of a series of menus that can be selected from the alphanumeric display. The operator is guided through the different displays by answering YES or NO to the appropriate prompt (change?, OK?, view?, next?, etc.) in the right corner of the lower row of the alphanumeric display.

To access the menus:

- If option 'SELECTOR in OFF: disabled' is configured, move the selector to OFF and then press simultaneously OPEN/YES and STOP push buttons to enter in the VIEW and SETUP menu.
- If option 'SELECTOR in OFF: enabled' is configured, move the selector to OFF and within 20 seconds, press simultaneously OPEN/YES and STOP push buttons to enter in the VIEW and SETUP menu. If VIEW and SETUP operation are not entered, a new ESD action will be executed.

It is possible to enter in VIEW and SETUP menu after ESD action has been executed, but the actuator cannot be electrically operated.

The alphanumeric display will now show the present language. Press YES if the language is correct, press NO to scroll the list of available languages and then press YES to select.

After choosing the language, the next step is the selection among view and set-up mode. Use view mode to see the actuator configuration, and use set-up mode to change the present configuration. Unauthorized access to the set-up mode is prevented by a 4-character alphanumeric password. The actuator is supplied by BIFFI with the default password '0000'.

Once the correct password has been entered, the actuator parameters can be configured.

The present password can also be modified by way of the 'set password' routine in the maintenance menu. After entering the new password, the old one ceases to be valid, so it is important to record the password in a secure location for future retrieval.

The configuration functions (view and set-up mode) are grouped in 4 main menus: Actuator set-up, Nameplate, Valve data, Maintenance.

10.4.1 Actuator set-up

This menu includes the routines that allow the actuator to be configured according to the requested control mode and to the valve it is mounted on.

List of routines:

- stroke limits
- out 4-20 mA *
- torque set-up
- interlock
- positioner *
- remote controls
- bus *
- local controls
- miscellaneous
- output relays
- EFS setup
- 2-speed timer
- fail safe *

The routines with * are only available if the relevant modules are present. If bus interface is LonWorks, the "bus" routine changes to "FDI control".

10.4.2 Name plate

This menu includes a series of data identifying the actuator characteristics, service, and utilisation mode. The data are entered by the manufacturer and can only be viewed (i.e. this menu is only available in View mode).

List of routines:

- serial number
- lubricant
- test date
- torque/thrust
- torque sensor
- enclosure
- certificate
- motor data
- actuator type
- revision
- wiring diagram
- actuator speed
- power supply

10.4.3 Valve data

Valve data includes a series of data relevant to the valve. The valve manufacturer and end user should enter the data.

List of routines:

- tag name
- manufacturer
- break-CL torque
- flange type
- serial number
- break-OP torque
- max stem thrust

BIFFI FAIL SAFE ELECTRIC ACTUATORS, MODEL EFS2000V4

INSTRUCTION AND OPERATING MANUAL

10.4.4 Maintenance

This menu includes all diagnostic and historic data which can help the operator in case of failure or during maintenance operations. The Maintenance menu also includes the "Set new password" routine.

List of routines:

Set-up mode

- Set new password
- Clear alarm log
- Set torque profile reference
- Set torque curve reference
- Clear recent data log
- Set maintenance date
- Set data logger
- Set PST reference
- PST command (normal or baseline)
- Set ESD reference

View mode

- Alarm log
- Torque profile
- Torque curve
- Operation log
- Maintenance date
- Data logger

The parameters appear on the alphanumeric display in the same order both in view and set-up mode. At the end of each routine, the program will automatically return to the beginning of the routine and the operator can choose to either re-enter (by pressing YES) or to move on to a next routine (by pressing NO). PST and EFS curves cannot be viewed by VIEW menu. They can only be viewed by PDA or PC connected by Bluetooth interface.

10.4.5 Entering the view mode

The existing actuator configuration should be checked before commissioning. The parameters are pre-configured according to a standard setting, or to the customer requirements. In view mode, no password is requested, but no change of parameters can be made.

If the option 'SELECTOR in OFF: disabled' is configured, move the selector to OFF and then press simultaneously OPEN/YES and STOP push buttons to enter in the VIEW and SETUP menu.

It is possible to enter in VIEW and SETUP menu after ESD action has been executed, but the actuator can not be operated electrically.

- Ensure the electrical main power is applied.
- Move the 3-position selector to OFF and then.
- If option 'SELECTOR in OFF: disabled' is configured, press simultaneously OPEN/YES and STOP push buttons to enter in the VIEW and SETUP menu. ESD action will not be executed.
- If option 'SELECTOR in OFF: enabled' is configured, press simultaneously OPEN/YES and STOP push buttons within 20 seconds to enter the VIEW and SETUP menu. If VIEW and SETUP operation are not entered, a new ESD action will be carried out.
- It is possible to enter in VIEW and SETUP menu after ESD action has been executed, but the actuator cannot be operated electrically.
- The display shows the present language. Press YES to confirm or NO to scroll the list of available languages. Press YES to select a new language. Press YES to confirm.
- Press NO to scroll the list of available menus (actuator set-up, nameplate, valve data, maintenance) and then press YES to select the desired menu.
- Press NO to scroll the list of available routines and press YES to select the routine where the parameter to be viewed is located.
- Press NO to scroll the list of parameters and press YES to view the value.

BIFFI FAIL SAFE ELECTRIC ACTUATORS, MODEL EFS2000V4

INSTRUCTION AND OPERATING MANUAL

10.4.6 Entering the set-up mode

To change the existing configuration or to set the stroke limits, it is necessary to enter the correct password.

- Ensure the electrical main power (or the external auxiliary supply) is applied.
- Move the 3-position selector to OFF and then:
- If option "SELECTOR in OFF: disabled" is configured, press simultaneously OPEN/YES and STOP push buttons to enter in the VIEW and SETUP menu. ESD action will not be executed.
- If option "SELECTOR in OFF: enabled" is configured, press simultaneously OPEN/YES and STOP push buttons for 20 seconds to enter in the VIEW and SETUP menu. If VIEW and SETUP operation are not entered a new ESD action will be executed.
- It is possible to enter in VIEW and SETUP menu after ESD action has been executed, but the actuator cannot be operated electrically.
- The display shows the present language. Press YES to confirm or NO to scroll the list of available languages. Press YES to select. Press YES to confirm the chosen language.
- Press NO when the message is "VIEW MODE OK?". Press YES to answer prompt "ENTER PASSWORD OK?"
- Enter password. Enter one digit at a time. Press YES if digit is correct, press NO to scroll through the list of available characters and then press YES when the character is correct. Enter 4 digits. After entering the last digit, the microprocessor checks the password. If it is correct the messages "PASSWORD CORRECT" and then "SET-UP MODE OK?" appear. Press YES.
- Press NO to scroll through the list of available menus (actuator set-up, valve data, maintenance) and press YES to select the desired menu.
- Press NO to scroll through the list of available routines and press YES to select the routine where the parameter to be changed is located.
- Press YES and NO to answer the prompt on the display and change the parameter.
- If the password is wrong the message "PASSWORD WRONG" appears and set-up mode will not available.

All settings are automatically saved to a non-volatile memory and retained also if the electrical power is removed from the actuator. All EFS2000 actuators are pre-configured with a default configuration, or to customers requirements.

In case of difficulty during commissioning, the default configuration can be re-instated by the appropriate function in the routine "miscellaneous" of the actuator set-up menu. The actuator returns to its original configuration and commissioning can be resumed.

10.4.7 Exit from view and set-up mode

The following conditions cause the exit from view and set-up mode:

- Move the 3-position selector to LOCAL or REMOTE.
- Answer YES when the display asks "EXIT OK?".
- Press YES and NO simultaneously.
- Automatic exit after 90 minutes without any parameter change or view.
- Remove the electrical power from the unit.

The following figure shows the procedure to enter VIEW and SET-UP mode.

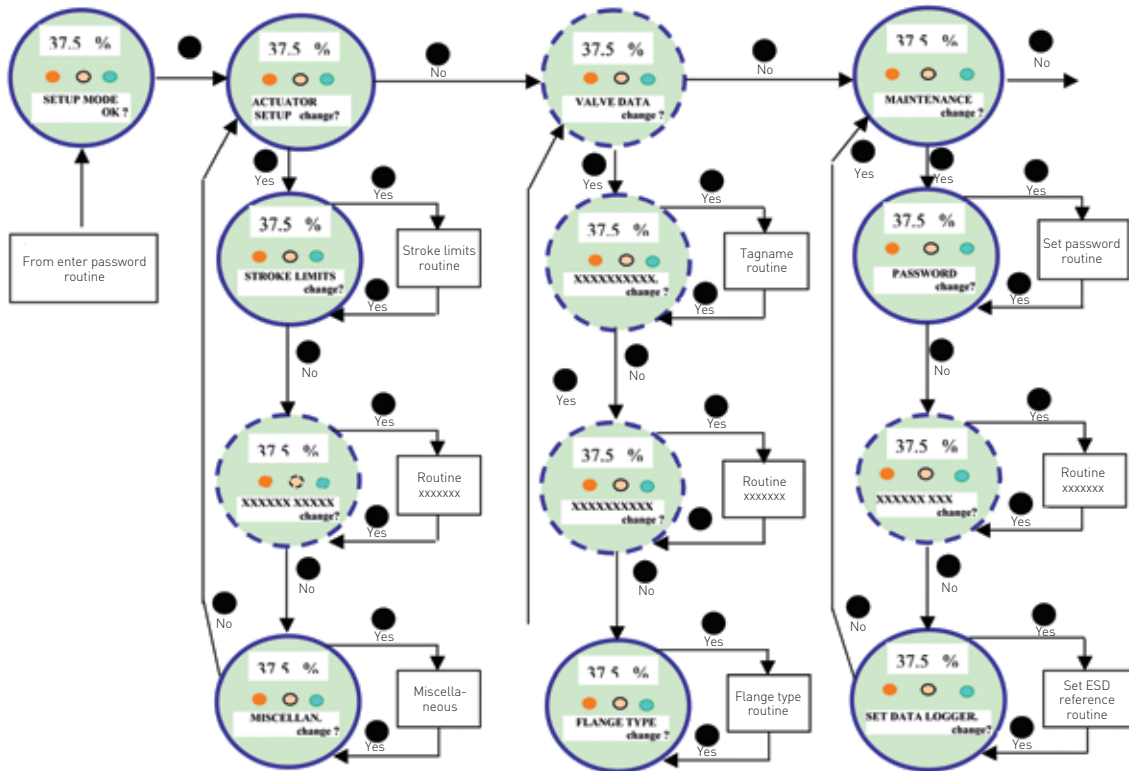

12 VIEW MENU

The below figure shows the procedure to move in the view routine.

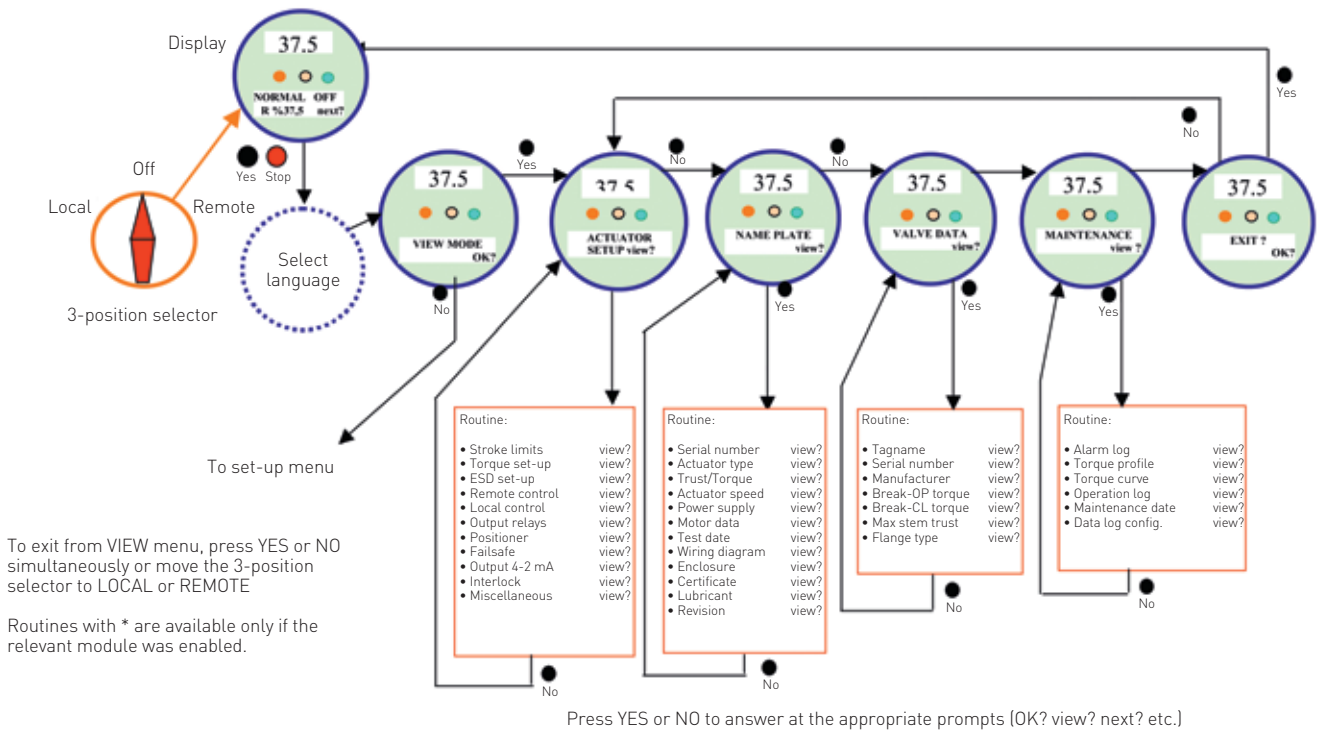

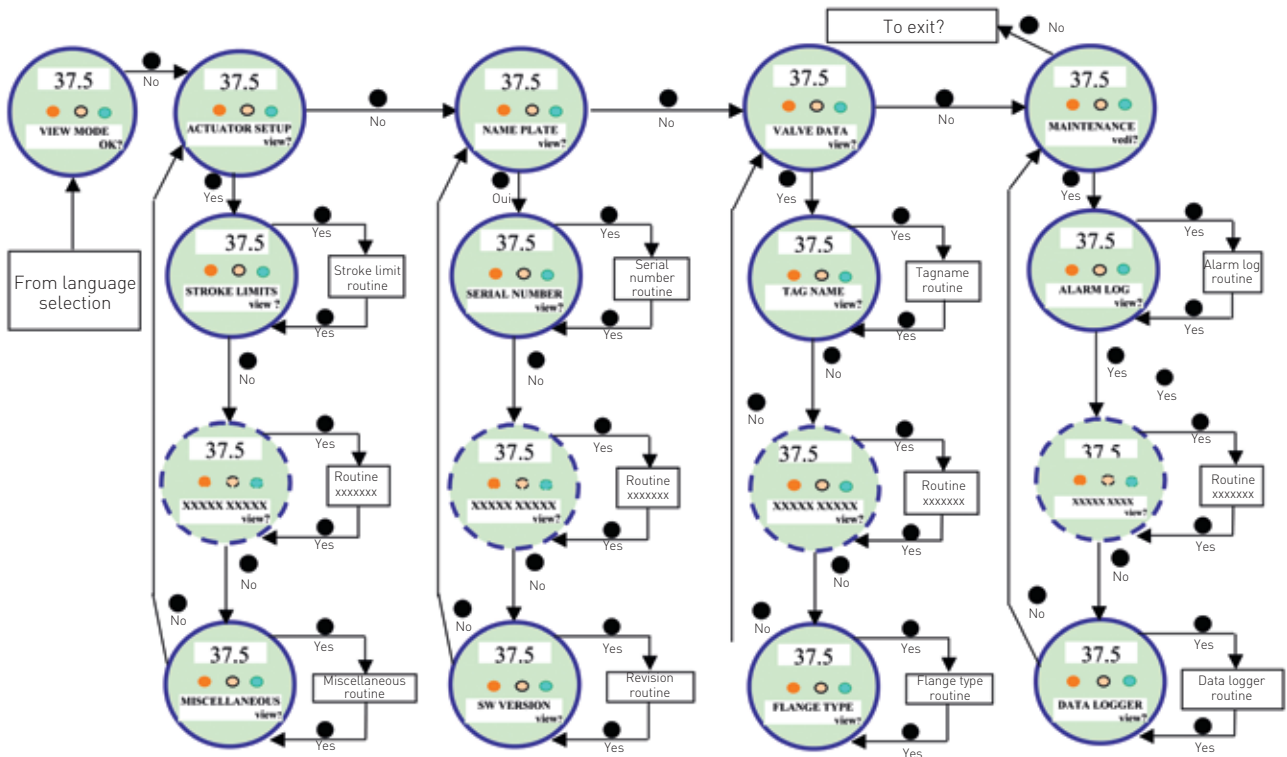

13 SET-UP ROUTINES

13.1 Actuator set-up

13.1.1 Set stroke limits

This routine allows the actuator to be configured according to the type of valve it is mounted on.

The following parameters will be set:

- Opening and closing torque limits: from 40% to 100% of the nominal torque. The nominal torque corresponding to 100% set in-house and stored in the name plate menu for reference.
- Close and open limits type: by position or by torque. Use the following table to choose: see table below.

Set-up procedure

Move the local selector to OFF and then simultaneously press OPEN and STOP within 20 sec (see chapter 'Local controls, entering the set-up mode'). Select the language and then enter the password according to the instructions. When the message displayed is "SET-UP MODE OK?" press YES. Press YES to select the actuator set-up menu, and then press YES again to start with the stroke limits routine.

Press YES if the closing torque limit is correct or NO to scroll the list of available values. When the value is correct, press YES.

Press YES if the opening torque limit is correct or NO to scroll the list of available values. When the value is correct press YES.

Press YES to set the close limit, or NO and then YES to set the open limit.

Close limit type

Press YES if the close limit type is correct (torque or position), press NO to change it. Press YES when the type is correct.

Close limit by position

Move the local selector to LOCAL. The local controls can be used.

Move the valve to closed position by local electrical command

Move the local selector to OFF

Press YES to confirm

Press YES to continue with the open limit setting, or press NO and again NO to repeat the close limit setting procedure. Press NO and then YES to exit from the stroke limits routine.

Close limit by torque

Move the local selector to LOCAL. The local controls can be used.

Press the CLOSE control. The actuator moves in closing direction and when the configured torque value is reached the motor is stopped and the new position limit is memorized.

Move the local selector to OFF

Press YES to confirm

Press YES to continue with the open limit setting, or press NO and again NO to repeat the close limit setting procedure. Press NO and then YES to exit from the stroke limits routine.

Open limit type

Press YES if the open limit type is correct (torque or position), press NO to change it.

Press YES to confirm.

Open limit by position

Move the local selector to LOCAL. The local controls become active.

Move the valve to open position

Move the local selector to OFF

Press YES to confirm

Press YES to exit, or press NO then YES to repeat the close limit setting procedure.

Open limit by torque

Move the local selector to LOCAL. The local controls become active.

Press the OPEN control. The actuator moves in opening direction and when the configured torque value is reached, the motor is stopped and the new position limit is memorized.

Move the local selector to OFF

Press YES to confirm

Press YES to exit, or press NO then YES to repeat the close limit setting procedure. If parameter 'direction to close' is changed, both limits (open and close) must be set. Before leaving the stroke limits routine the microprocessor calculates the new value of the position resolution. If the stroke turns are less than 2.7, the message 'error re-try' appears and the stroke limits procedure must be repeated.

The above procedure can be done also in MANUAL mode by the manual override command (hand pump and the hand operated spring return valve, hydraulic control group) in place of the electrical actuator commands.

| Valve type | Close limit | Open limit |
|--|--------------------|------------|
| Gate (solid, flexible and split wedge), globe, metal seated butterfly valves | Torque | Position |
| Ball, gate (parallel slide), plug valves, metal seated butterfly valves | Position | Position |
| Linear valves with back-seating on stem | Torque or position | Torque |

BIFFI FAIL SAFE ELECTRIC ACTUATORS, MODEL EFS2000V4

INSTRUCTION AND OPERATING MANUAL

13.1.2 Torque set-up

The output torque limits to close or to open may be configured between 40% and 100% of the nominal torque stated on the actuator nameplate.

Set-up procedure

- Move the local selector to OFF and then simultaneously press OPEN and STOP within 20 sec (see chapter 'Local controls, entering the set-up mode'). Select the language and then enter the password according to the instructions. When the message displayed is 'SET-UP MODE OK?' press YES. Press YES to select the actuator set-up menu, press NO and then press YES to select the torque set-up routine.
- Press YES if the opening torque limit is correct, press NO to scroll the list of available values. Press YES when the value is correct.
- Press YES if the closing torque limit is correct, press NO to scroll the list of available values. Press YES when the value is correct.

13.1.3 EFS set-up

The EFS setup routine allows configuring the parameters of EFS and of PST functions. The following parameters relevant to EFS function can be set:

- ICON power-fail: enabled or disabled.
- Selector in OFF: enabled or disabled.
- Auto reset: enabled or disabled.
- Reset delay: from 1 to 255 sec. The recommended value is greater than 1.5 times the maximum valve stroke time during EFS action.

The following parameters relevant to PST function can be set:

- PST mode: OFF, AUTO, MANUAL.
- OFF: PST not used.
- AUTO: PST cycle carried out automatically and cyclically with time interval set by the parameter PERIOD and at the time set by the parameter HOUR of DAY.
- MANUAL: PST cycle carried out on receiving of a remote hardwired or bus command or by a local command available in the VIEW and SETUP menu, maintenance functions.
- MAN-AUTO: both automatic and manual mode are available.
- SPRING action: spring to open or spring to close.

- PERIOD: time interval between PST, in days from 1 to 1000, in PST AUTO mode.
- HOUR of DAY: hour of PST, in hour from 0 to 23, in PST AUTO mode.
- PST TRAVEL: position change during PST cycle, in % of position from 10 to 40.
- MAX T-PST: max time allowed changing the position of PST TRAVEL due to spring action, measured in %, from 1 to 1000% of relevant BASELINE time.
- MAX PST T-RET: max time to return to initial position by the electrical actuator, measured in %, from 1 to 1000% of relevant BASELINE time.
- PAUSE: time of current position of actuator after spring action and before command to return to initial position, in sec, from 2 to 255.
- MAX PST OV-TR: max position over-travel allowed during PST cycle, in percentage of position, from 1 to 100.

The function of each parameter is described in the chapter 'EFS operation'.

Set-up procedure

EFS Set-up

- Move the local selector to OFF and then simultaneously press OPEN and STOP within 20 sec (see chapter 'Local controls, entering the set-up mode'). Select the language and then enter the password according to the instructions. When the message displayed is 'SET-UP MODE OK?' press YES. Press YES to select the actuator set-up menu, press NO to select the list of available routines. Press YES to select 'EFS SETUP'.
- Press YES if the parameter 'ICON power-fail' is correct, press NO to change. Press YES when the value is correct.
- Press YES if the parameter 'Selector in OFF' is correct, press NO to change. Press YES when the value is correct.
- Press YES if the parameter 'AUTORESET' is correct, press NO to change. Press YES when the value is correct.
- Press YES if the parameter 'Reset delay' is correct, press NO to scroll the list of available values. Press YES when the value is correct.
- Press YES to enter in the PST SETUP, press NO to return to EFS SETUP. Press NO to move to next routine.

PST Set-up

- Press YES if the parameter 'PST mode' is correct, press NO to scroll through the list of available values. Press YES when the value is correct.
- Press YES if the parameter 'SPRING ACTION' is correct, press NO to change. Press YES when the value is correct.
- Press YES if the parameter 'PERIOD' is correct, press NO to scroll through the list of available values. Press YES when the value is correct.
- Press YES if the parameter 'HOUR of DAY PST' is correct, press NO to scroll through the list of available values. Press YES when the value is correct.
- Press YES if the parameter 'PST TRAVEL' is correct, press NO to scroll through the list of available values. Press YES when the value is correct.
- Press YES if the parameter 'MAX T-PST' is correct, press NO to scroll through the list of available values. Press YES when the value is correct.
- Press YES if the parameter 'MAX PST T-RET' is correct, press NO to scroll through the list of available values. Press YES when the value is correct.
- Press YES if the parameter 'PAUSE' is correct, press NO to scroll the list of available values. Press YES when the value is correct.
- Press YES if the parameter 'MAX PST OV-TR' is correct, press NO to scroll through the list of available values. Press YES when the value is correct to return to PST SETUP.
- Press NO to return to EFS SETUP. Press NO to move to next routine.

13.1.4 Remote controls

The actuator may be remotely controlled by 4, or 3, or 2 wires depending on the connection made on the terminal board of the actuator.

The following options are available:

- 4 wires latched: requires 2 momentary signals (since the control is self-maintained) to open or close and one signal to stop in mid-travel. The action of the stop signal can be reversed (stop when signal is ON (MAKE) or stop when signal is OFF (BREAK).
- 3 wires latched instant reverse: requires 2 momentary signals (since the control is self-maintained) to open or close. Reverse momentary signal reverses the direction.
- 3 wires momentary: requires 2 push-to-run type signals (since the control is not self-maintained) to open or close
- 2 wires open if signal On: requires signal On to open and no signal to close
- 2 wires open if signal Off: requires signal Off to open and signal On to close

By selecting the option 'Off', the remote controls are disabled.

Configuration should be done during actuator set-up.

Setup procedure

- Move the local selector to OFF and then simultaneously press OPEN and STOP within 20 sec (see chapter 'Local controls, entering the set-up mode'). Select the language and then enter the password according to the instructions (see 'Entering the set-up mode'). When the message displayed is 'SET-UP MODE OK?' press YES. Press YES to select actuator set-up menu, press NO to scroll the list of available routines and then press YES to select Remote controls.
- Press YES if the control mode is correct or NO to scroll the list of available options: 4 wires, 3 wires, 2 wires, off. Press YES to select the desired option. If 4 wires were chosen use YES and NO to select the STOP signal: set MAKE to stop when signal is on and set BREAK to stop when signal is off. If '3 wires' was chosen, use YES or NO to answer the prompt on the display and choose among 'push-to-run' or 'latched instant reverse' control modes. If '2 wires' was chosen, use YES and NO to choose among 'open if signal ON' or 'open if signal OFF' control modes.

13.1.5 Local controls

This routine allows:

- To configure the control mode by means of the local controls when the 3-position selector is in LOCAL. The available options are 'push-to-run', 'latched', 'latched with instant reverse'.
- To set the LED's color. The following options are available: open LED: green or red; close LED: green or red; alarm LED: yellow or red.

Configuration procedure

- Move the local selector to OFF and then simultaneously press OPEN and STOP within 20 sec (see chapter 'Local controls, entering the set-up mode'). Select the language and then enter the password according to the instructions (see 'Entering the set-up mode'). When the message displayed is 'SET-UP MODE OK?' press YES. Press YES to select the actuator set-up menu, press NO to scroll the list of available routines and then press YES to select Local controls.
- Press YES to change control mode, or press NO to proceed to LED's color setting.

BIFFI FAIL SAFE ELECTRIC ACTUATORS, MODEL EFS2000V4

INSTRUCTION AND OPERATING MANUAL

Control mode

Press YES if the display shows the correct control mode or press NO to scroll through the list of available options (push-to-run, latched, latched with instant reverse, push to run rel. As5-6). Press YES to confirm.

The option 'push to run rel. As5-6' is used when a remote enable of local commands is required. With the local selector in LOCAL, to press the OPEN or CLOSE local push buttons cause the relays As5 or AS6 to switch, but no command is sent to the motor. The control PLC should read the status of the above relays and send an open or close command on the remote inputs. (see chapter 'remote controls, push to run mode') (see relevant electrical diagram when the option is used).

LED's color

- Press YES if the color of the open LED is correct. Press NO to change it, then YES to confirm.
- Press YES if the color of the close LED is correct. Press NO to change it, then YES to confirm.
- Press YES if the color of the alarm LED is correct. Press NO to change it, then YES to confirm.

13.1.6 Output relays

Monitor relay

The voltage-free, change-over, contacts of the monitor relay indicate that the actuator is either available for remote control or that a problem or a condition preventing remote control of the valve exists.

The monitor relay is normally energized and will be de-energized on:

- Main voltage failure
- Lost phase
- Internal temperature alarm
- K1, K2 contactor failure
- Position sensor failure
- Speed sensor failure
- Configuration error
- HWerror
- Mid travel alarm
- EFS mid-travel alarm
- EFS in MANUAL mode

The following situation can be individually added to switch-over the monitor relay:

- LOCAL/STOP pressed
- LOCAL/OFF selected
- ESD-EFS
- Manual operation
- Motor over-temperature
- Over-torque
- Jammed valve
- Low lithium battery (if present)

Auxiliary output relays

For status indication or diagnostic purposes, 8 voltage-free contacts of 8 relays are available to be configured individually to switch for the following conditions:

| Status | | Alarm | |
|--------------------|-----------------------|--------------------------|------------------------------------|
| • Open limit | • Blinker | • Motor over-temperature | • Low lithium battery (if present) |
| • Closed limit | • Mid-travel position | • Over-torque | • Warnings |
| • Position >= xx % | • Local selected | • Over-torque in OP | • Mid travel alarm in CL/OP |
| • Position <= xx % | • Remote selected | • Over-torque in CL | • EFS in MANUAL |
| • Closing | • Local stop pressed | • Valve jammed in OP | • PST failed |
| • Opening | • PST signal active | • Valve jammed in CL | • MAINS-only AS8 |
| • Motor running | • Manual operation | • Valve jammed | • EFS mid travel |

BIFFI FAIL SAFE ELECTRIC ACTUATORS, MODEL EFS2000V4

INSTRUCTION AND OPERATING MANUAL

The contacts may be configured to make or break on condition.

Configuration procedure

- Move the local selector to OFF and then simultaneously press OPEN and STOP within 20 sec (see chapter 'Local controls, entering the set-up mode'). Select the language and enter the password according to the instructions (see 'Entering the set-up mode'). When the message displayed is 'SET-UP MODE OK?' press YES. Press YES to select actuator set-up menu, press NO to scroll through the list of available routines and then press YES to select Output relays.
- Press YES to select DEFAULT #1, or press NO to change
- Press YES to select DEFAULT #2, or press NO to configure the output relays

DEFAULT #1

Monitor relay

- Main voltage failure
- Speed sensor failure
- Lost phase
- Configuration error
- Local/off selected
- HW error
- Local stop pressed
- Motor over-temperature
- Manual operation
- Over-torque
- Internal temperature alarm
- Jammed valve
- K1 contactor failure
- Low a lithium battery (if present)
- K2 contactor failure
- Mid-travel alarm
- Position sensor failure

Auxiliary relays

AS1: open limit; make
AS2: close limit; make
AS3: position >90%; make
AS4: position <5%; make
AS5: motor running; make
AS6: overtorque; make
AS7: ESD active; make
AS8: motor over-temperature

DEFAULT # 2

Monitor relay

- Main voltage failure
- Speed sensor failure
- Lost phase

- Configuration error
- Local/off selected
- HW error
- Local stop pressed
- Motor over-temperature
- Manual operation
- Over-torque
- Internal temperature alarm
- Jammed valve
- K1 contactor failure
- Low lithium battery (if present)
- K2 contactor failure
- Mid-travel alarm
- Position sensor failure

Auxiliary relays

AS1: open limit; break
AS2: close limit; break
AS3: position >90%; break
AS4: position <5%; break
AS5: motor running; make
AS6: remote selected; make
AS7: warning; make
AS8: local selected

Configure output relays

- Press YES to change the monitor relay or NO to change auxiliary relays AS1, 2, 3, 4, 5, 6, 7, 8.

Monitor relay

- Press YES or NO to enable or disable the following situations from the conditions which de-energize the monitor relay: motor over-temperature, over-torque, jammed valve, manual override, ESD-EFS, low lithium battery (if present), local STOP pressed, LOCAL/OFF selected.

Auxiliary relays AS1, 2, 3, 4, 5, 6, 7 and 8

- Press NO to answer prompt 'MONITOR RELAY change?'.
• Press YES to change AS1, press NO to select the other relays.
• Press YES if the condition associated to AS1 relay is correct, press NO to scroll through the list of conditions and press YES to set.
• Press YES or NO to either confirm or change the type of contact when the condition occurs (break, make). Since relay AS8 is change-over, this option is not available.
• Press NO to pass to AS2 and then repeat the procedure for the other relays.
• Press NO to exit.

BIFFI FAIL SAFE ELECTRIC ACTUATORS, MODEL EFS2000V4

INSTRUCTION AND OPERATING MANUAL

13.1.7 Positioner

The positioning function is only available in modulating EFS2000v4 actuators and allows to position the valve according to a 'position request R%' command signal. The positioning function compares the present actuator position % with the position request R%, and if the difference is greater than the dead band the actuator is driven to reach the new requested position. The 'position request R%' signal may either be received from the bus or the 4-20 mA analog input. If the ICON2000 is set to receive the position request R% from the BUS, a fieldbus interface card must be present, or a hardware alarm will be generated. If the ICON2000 is set to receive the position request R% from the 4-20 mA generator, the Ain/Aout card must be present, or a hardware alarm will be generated. The following options can be configured via local operator interface:

- Dead band: configurable from 'position resolution%' to 25.5% of the maximum position error. The configured value should be large enough to avoid the hunting effect.
- Polarity of the 4-20 mA position request signal: it allows to reverse the relationship between the 4-20 mA input signal and the 'position request R%', according to the following diagrams. This option is not available when the ICON2000 is set to receive the 'position request R%' from the bus.
- Motion inhibit time: it allows to adjust the length of the delay time between two cycles of the motor. It can be configured from 1 to 255 secs and allows setting the maximum number of start/hour of the electrical motor.
- % MIN and % MAX, 4-20 mA input signal range: it allows to change the relationship between the input signal and the position request R%. This function is useful when a single 4-20 mA signal is used to control the position of 2 valves (e.g.: split range applications). The option is not available when the ICON2000 is set to receive the 'position request R%' from the bus.

The following examples will clarify the above option:

- example a):** with input signal = 4 mA, the position request is 0% and the actuator is driven to close. With input signal = 20 mA, the position request is 100% and the actuator is driven to open. With input signal = 12 mA the position request is 50% and the actuator is driven to reach position 50%.
- example b):** with input signal < 8 mA, the position request is 0% and the actuator is driven to close. With input signal = 16 mA, the position request is 100% and the actuator is driven to open. With input signal = 12 mA the position request is 50% and the actuator is driven to reach position 50%.
- example c):** with input signal = 4 mA, the position request is 100% and the actuator is driven to open. With input signal = 20 mA, the position request is 0% and the actuator is driven to close. With input signal = 12 mA the position request is 50% and the actuator is driven to reach position 50%.
- example d):** with input signal < 8 mA, the position request is 100% and the actuator is driven to open. With input signal = 16 mA, the position request is 0% and the actuator is driven to close. With input signal = 12 mA the position request is 50% and the actuator is driven to reach position 50%.

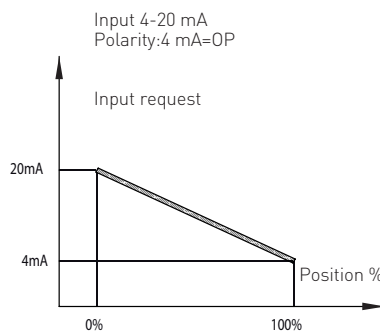
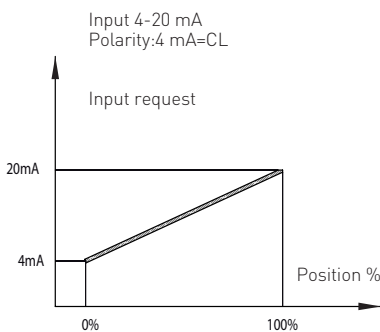

BIFFI FAIL SAFE ELECTRIC ACTUATORS, MODEL EFS2000V4

INSTRUCTION AND OPERATING MANUAL

Configuration procedure

- Move the local selector to OFF and then simultaneously press OPEN and STOP within 20 sec [see chapter 'Local controls, entering the set-up mode']. Select the language and then enter the password according to the instructions (see entering the set-up mode). When the message displayed is 'SET-UP MODE OK?' press YES. Press YES to select the actuator set-up menu, press NO to scroll through the list of available routines and then press YES to select FAIL SAFE.
- Press YES if the configured ACTION is correct (open, close, stay-put, go to position xxx%, off), or press NO to change it, then press YES.

- Press YES if the configured value of the DELAY is correct (from 0 to 255 sec), or press NO to change it, then press YES.

13.1.9 OUT 4-20 mA

This routine is only available if the Ain/Aout card is present. With this card the ICON2000 is provided with a 4-20 mA analog input and a 4-20 mA analog output. The 4-20 mA output can be configured to provide a current proportional to either 'position' or 'torque'. The polarity option allows to reverse the relationship between the present position or torque and the 4-20 mA output signal, according to the following diagrams:

Configuration procedure

- Move the local selector to OFF and then simultaneously press OPEN and STOP within 20 sec [see chapter 'Local controls, entering the set-up mode']. Select the language and then enter the password according to the instructions (see 'entering the set-up mode'). When the message of the display is 'SET-UP MODE OK?' press YES. Press YES to select the actuator set-up menu, press NO to scroll through the list of available routines and then press YES to select Out 4-20 mA.
- Press YES if the output is correct (POSITION or TORQUE), or press NO to change it, then press YES.
- Press YES if the polarity is correct, or press NO to change it, then press YES.

Output: position

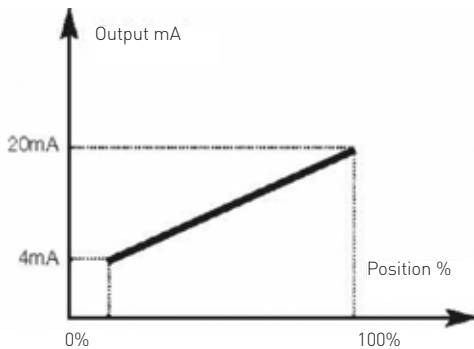

Polarity: 4 mA = CL

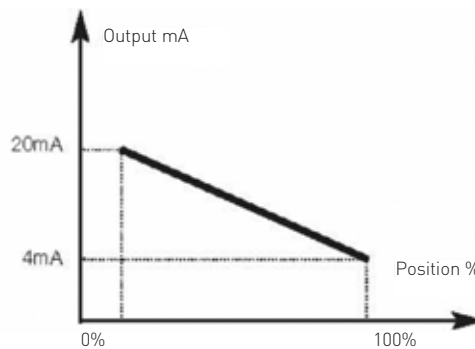

Polarity: 4 mA = OP

Output: torque

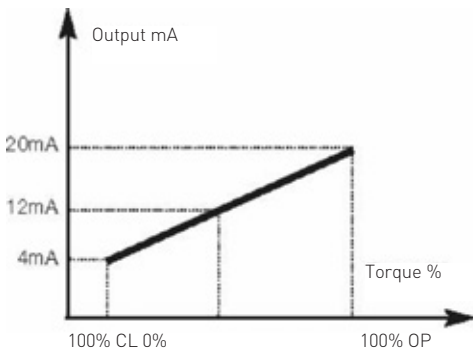

Polarity: 4 mA = CL

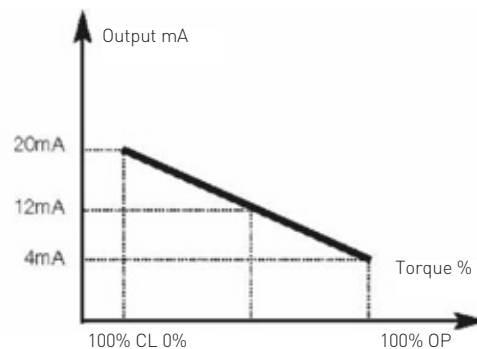

Polarity: 4 mA = OP

13.1.10 Interlock

The interlock inputs can be used to inhibit the actuator movement in open or close direction. The controls are momentary, the inhibit action continues until the relevant signal is present. The interlock controls work when the local selector is in LOCAL or in REMOTE. The ESD control overrides the interlock controls. The following options can be configured:

- Interlock OP: active when signal is PRESENT, active when signal is ABSENT, no action (OFF).
- Interlock CL: active when signal is PRESENT, active when signal is ABSENT, no action (OFF).

Configuration procedure

- Move the local selector to OFF and then simultaneously press OPEN and STOP within 20 sec (see chapter 'Local controls, entering the set-up mode'). Select the language and then enter the password according to the instructions (see entering the set-up mode). When the message displayed is 'SET-UP MODE OK?' press YES. Press YES to select the actuator set-up menu, press NO to scroll through the list of available routines and then press YES to select INTERLOCK.
- Press YES if the configured value of the Open Interlock is correct (PRESENT, ABSENT, OFF), or press NO to change it, then press YES.
- Press YES if the configured value of the Close Interlock is correct (PRESENT, ABSENT, OFF), or press NO to change it, then press YES.

13.1.11 Two-speed timer

The "2-speed timer" routine is used to extend the actuator traveling time in opening and/ or closing direction, by driving the motor by pulses which duration (ON and OFF time) is configurable. Pulsing control can be applied to full travel or only a part of it.

Start position and stop position may be adjusted from 0% - 100% separately in opening and closing direction.
 ON time and OFF time may be adjusted from 2 sec - 200 sec separately in opening and closing direction.

Configuration procedure

- Move the local selector to OFF and then simultaneously press OPEN and STOP within 20 sec (see chapter 'Local controls, entering the set-up mode'). Select the language and then enter the password according to the instructions (see 'Entering the set-up mode'). When the message displayed is 'SET-UP MODE OK?' press YES. Press YES to select actuator set-up menu, press NO to scroll through the list of available routines and then press YES to select 2-speed timer.
- Press YES to change close direction parameters, press NO and then YES to change only open direction parameters.

Closing direction

- Press YES if the status is OK, or NO to change. Press YES to confirm (status = On, enables 2-speed timer operation in closing direction; status = Off, disables timer operation in closing direction).
- Press YES if the position value where pulsing control starts is correct, press NO to scroll through the list of available values. Press YES when the value is correct.
- Press YES if the position value where pulsing control stops is correct, press NO to scroll through the list of available values. Press YES when the value is correct.
- Press YES if the value of the ON time of pulsing control is correct, press NO to scroll through the list of available values. Press YES when the value is correct.
- Press YES if the value of the OFF time of pulsing control is correct, press NO to scroll through the list of available values. Press YES when the value is correct.

Opening direction

- Press YES if the status is OK, or NO to change. Press YES to confirm (status = On enables 2-speed timer operation in opening direction; status = Off, disables timer operation in opening direction).
- Press YES if the position value where pulsing control starts is correct, press NO to scroll through the list of available values. Press YES when the value is correct.

- Press YES if the position value where pulsing control stops is correct, press NO to scroll through the list of available values. Press YES when the value is correct.
- Press YES if the value of the ON time of pulsing control is correct, press NO to scroll through the list of available values. Press YES when the value is correct.
- Press YES if the value of the OFF time of pulsing control is correct, press NO to scroll through the list of available values. Press YES when the value is correct.

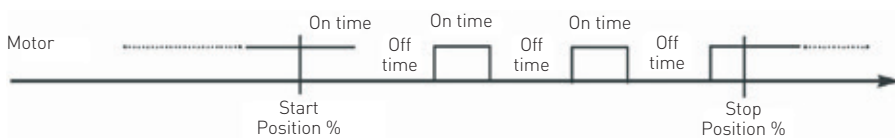

BIFFI FAIL SAFE ELECTRIC ACTUATORS, MODEL EFS2000V4

INSTRUCTION AND OPERATING MANUAL

13.1.12 BUS (or FDI control)

This routine is only available if a fieldbus interface card is present. The routine allows the configuration of the most important parameters (node address, termination, etc.) necessary to connect the actuator to a fieldbus. If the ICON2000 was set to work with fieldbus, but the fieldbus card is not present, a Hardware alarm will be generated. Different interfaces are available to connect the EFS2000 to different types of fieldbus. If the bus interface is LonWorks, the routine 'Bus' changes in 'FDI control'. See the specific manuals for instruction and setting of the above modules.

13.1.13 Miscellaneous

Miscellaneous includes different types of routines as 'time and date', 'factory settings', 'lithium battery', 'torque profile', etc. used only for special application or in particular conditions.

13.1.13.1 Time and date

Time and date are used in maintenance functions to associate the time information to the memorized event (torque profile, alarm log, maintenance request, etc.). Time and date are entered at the time of manufacture, but they can be adjusted during commissioning or maintenance operations.

13.1.13.2 Factory settings

The above routine resets the present configuration and restores the default configuration as below:

| | | |
|-----------------|--------------------|---|
| Stroke limits | Close limit: | By position |
| | Open limit: | By position |
| Torque set-up | Closing torque: | 40% |
| | Opening torque: | 40% |
| Remote controls | Control type: | 4 Wires latched |
| Locals controls | Control type: | Latched with instant reverse |
| | LED's color: | Green = open / opening Red = close / closing Yellow = alarm / warning |
| Output relay | Default #1 | |
| 2-speed timer | Opening direction: | Off |
| | Closing direction: | Off |
| Miscellaneous | Lithium battery: | Absent |
| | Torque profile: | Standard |
| | Torque by-pass: | 4% |
| | Valve jammed: | 4 Sec. |

Configuration procedure

- Move the local selector to OFF and then simultaneously press OPEN and STOP within 20 sec [see chapter 'Local controls, entering the set-up mode']. Select the language and then enter the password according to the instructions (see 'Entering the set-up mode'). When the message displayed is 'SET-UP MODE OK?' press YES. Press YES to select the actuator set-up menu, press NO to scroll through the list of available routines and then press YES to select Miscellaneous.

Configuration procedure

- Move the local selector to OFF and then simultaneously press OPEN and STOP within 20 sec [see chapter 'Local controls, entering the set-up mode']. Select the language and enter the password according to the instructions (see 'Entering the set-up mode'). When the message displayed is 'SET-UP MODE OK?' press YES. Press YES to select the actuator set-up menu, press NO to scroll through the list of available routines and then press YES to select Miscellaneous.
- Press YES to enter the time and date routine.
- Press YES if the time is correct, press NO to change it.
- Enter hours, minutes and seconds. Press NO to scroll the list of available values, press YES to select.
- Press YES when the time is correct
- Press YES if the date is correct, press NO to change.
- Enter day, month, and year. Press NO to scroll the list of available values, press YES to select.
- Press YES if the date is correct.

- Press No to scroll through the list of routines and press YES to select factory configuration. Press YES to download the standard configuration, press NO to exit.

WARNING!

The **FACTORY SETTING** routine set the parameter 'close direction' to 'CW'. The parameter is located in the protected area of memory and it is available only by using a special password. In the EFS it must be always configured 'CCW'. It is necessary to call the Biffi service to modify the above parameter if factory setting routine is used.

BIFFI FAIL SAFE ELECTRIC ACTUATORS, MODEL EFS2000V4

INSTRUCTION AND OPERATING MANUAL

Actuator direction: closing

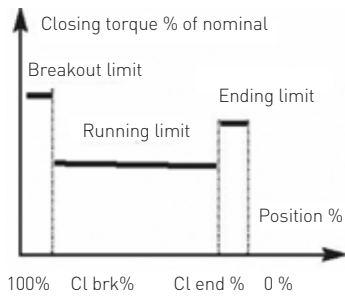

Actuator direction: opening

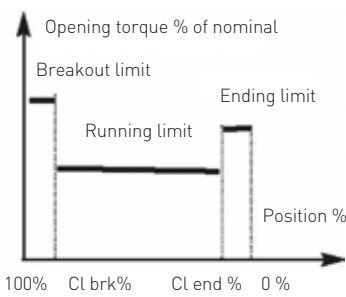

13.1.13.3 Torque limits

Torque limits are used as a reference for torque alarm and end of travel. With option 'standard', the torque limits are constant along the full stroke. The limits can be configured in the 'stroke limits' or 'torque set-up' routines and determine the torque alarm or end of travel situations. In some special applications it is useful to configure 3 different torque thresholds for each traveling direction, so as to separately limit the unseating, running and ending torque values. To select this option, pick '3-point limits' and follow the torque set-up and stroke limits routine (see figure below).

Configuration procedure

- Move the local selector to OFF and then simultaneously press OPEN and STOP within 20 sec (see chapter 'Local controls, entering the set-up mode'). Select the language and then enter the password according to the instructions (see 'Entering the set-up mode'). When the message of the display is 'SET-UP MODE OK?' press YES. Press YES to select the actuator set-up menu, press NO to scroll through the list of available routines and then press YES to select Miscellaneous.
- Press NO, and then NO to select 'torque mode'. Press YES if the setting is correct, press NO to change it. Press YES when the value is correct.
- Repeat the 'stroke limits set-up' routine.

13.1.13.4 Lithium battery

On request, the actuator can be provided with a lithium battery to update the remote outputs (output relays status and bus messages) in case of electrical power failure and manual override operations. The program runs the functions relevant to the battery only if the appropriate flag 'lithium battery' is configured with 'present'. If the battery is absent or if no updating of remote outputs is requested, the above flag should be configured with 'absent'.

Configuration procedure

- Move the local selector to OFF and then simultaneously press OPEN and STOP within 20 sec (see chapter 'Local controls, entering the set-up mode').

Select the language and enter the password according to the instructions (see 'Entering the set-up mode'). When the message displayed is 'SET-UP MODE OK?' press YES. Press YES to select actuator set-up menu, press NO to scroll through the list of available routines and then press YES to select Miscellaneous.

- Press No to scroll the list of routines and press YES to select lithium battery. Press YES if the setting is correct, press NO to change. Press YES when the value is correct.

13.1.13.4.1 Torque by-pass (%)

Since a high torque may be required to unseat certain valves, the torque by-pass routine masks the torque alarm when an open or close command is received and the actuator is fully open or closed. The torque by-pass is expressed in % of position and is configurable from 0% to 20%. For example, if a 10% by-pass value is set, we may have:

- by-pass active in Opening: from 0% to 10%
 - by-pass active in Closing: from 100% to 90%
- To exclude torque by-pass configure 0%.

Configuration procedure

- Move the local selector to OFF and then simultaneously press OPEN and STOP within 20 sec (see chapter 'Local controls, entering the set-up mode'). Select the language and enter the password according to the instructions (see 'Entering the set-up mode'). When the message displayed is 'SET-UP MODE OK?' press YES. Press YES to select actuator set-up menu, press NO to scroll through the list of available routines and then press YES to select Miscellaneous.
- Press No to scroll through the list of routines and press YES to select torque by pass. Press YES if the setting is correct, press NO to change. Press YES when the value is correct.

13.1.13.5 Valve jammed (time)

The valve jammed time is used to monitor the following situations:

1. The time passed after receiving an open or close control is longer than the 'valve jammed time', but the valve position variation is smaller than 0,5%. The motor is blocked, the command is cleared and the 'valve jammed' alarm indication is generated.
2. The valve is moving, but during the travel the position valve variation is smaller than 0,5% in a time equal to 'valve jammed time'. The motor is blocked, the command is cleared and the 'mid-travel alarm' indication is generated.

The valve jammed time is expressed in seconds and can be configured from 0 to 100 sec. Configure '0' to exclude the routine.

Configuration procedure

- Move the local selector to OFF and then simultaneously press OPEN and STOP within 20 sec (see chapter "Local Controls, entering the set-up mode"). Select the language and enter the password according to the instructions (see 'Entering the set-up mode'.) When the message displayed is 'SET-UP MODE OK?' press YES. Press YES to select actuator set-up menu, press NO to scroll through the list of available routines and then press YES to select Miscellaneous.
- Press No to scroll through the list of routines and press YES to select valve jammed. Press YES if the setting is correct, press NO to change. Press YES when the value is correct.

13.2 Valve data

The valve data allow identifying the valve and its function in the process. The valve manufacturer and the end user can enter the data. The following data can be entered:

- Tag name (max. 28 char.)
- Serial number (max. 28 char.)
- Manufacturer (max. 28 char.)
- Break-OP torque (max. 28 char.)
- Break-CL torque (max. 28 char.)
- Max stem thrust (max. 28 char.)
- Flange type(max. 28 char.)

Configuration procedure

- Move the local selector to OFF and then simultaneously press OPEN and STOP within 20 sec (see chapter "Local controls, entering the set-up mode"). Select the language and enter the password according to the instructions (see 'Entering the set-up mode'). When the message displayed is 'SET-UP MODE OK?' press YES. Press NO to scroll through the list of available menus and then press YES to select valve data menu.
- Press NO to scroll through the list of available routines and then press YES to select the data to be changed (tagname, serial number, etc).
- Press YES if the 1st character of the string is correct. Press NO to scroll through the list of available characters. Press YES to select the desired character.
- Enter up to 28 characters. Enter a blank character, and '.....' as end of string.

13.3 Maintenance

A large amount of data is stored in the actuator memory and is available for future analysis or to assist the operator in the maintenance program. The maintenance menu also includes the set password routine, and the possibility to modify or start the maintenance functions. The following data are available:

- Set password
- Clear alarm log
- Set torque reference
- Set curve reference
- Clear recent data log
- Set maintenance date
- Set data logger
- Set EFS baseline
- Set PST baseline
- PST command (normal or baseline)

13.3.1 Set password

The actuator is supplied with a default password ('0 0 0 0'). According to the above mentioned routine, the end user can enter a different password consisting of 4 alphanumeric characters. After entering the new password, the old one ceases to be valid. Therefore it is mandatory not to forget the password after the default one has been modified. Forgetting the new password makes it impossible to enter the set-up menu and to configure the actuator.

Configuration procedure

- Move the local selector to OFF and then simultaneously press OPEN and STOP within 20 sec (see chapter 'Local controls, entering the set-up mode'). Select the language and enter the password according to the instructions (see 'Entering the set-up mode'). When the message displayed is 'SET-UP MODE OK?' press YES. Press NO to scroll through the list of available menus and then press YES to select Maintenance menu.
- Press NO to scroll through the list of available routines and then press YES to select Set password. Press YES again to select Enter new password.
- Enter the new password one digit at a time. Press YES if the digit is correct, press NO to scroll through the list of available characters and then press YES to select. Enter 4 digits. When the display shows the message: 'Password changed', the old password is no longer valid.

13.3.2 Clear alarm log

Clear procedure

- Move the local selector to OFF and then simultaneously press OPEN and STOP within 20 sec (see chapter 'Local controls, entering the set-up mode'). Select the language and enter the password according to the instructions (see 'Entering the set-up mode'). When the message displayed is 'SET-UP MODE OK?' press YES. Press NO to scroll through the list of available menus and then press YES to select the Maintenance menu.
- Press NO to scroll through the list of available routines and then press YES to select clear alarm log.
- Press YES to clear alarm log.

13.3.3 Set torque reference

The set torque profile reference routine allows to transfer the last torque profile to the reference profile registers. The old reference data are lost and the new ones are used as a new reference torque profile.

- Move the local selector to OFF and then simultaneously press OPEN and STOP within 20 sec (see chapter 'Local controls, entering the set-up mode'). Select the language and enter the password according to the instructions (see 'Entering the set-up mode'). When the message displayed is 'SET-UP MODE OK?' press YES. Press NO to scroll through the list of available menus and then press YES to select the Maintenance menu.
- Press NO to scroll through the list of available routines and then press YES to select set torque reference.
- Press YES to update the torque reference data.

13.3.4 Set curve reference

The 'set curve reference' routine allows to select 1 of 100 opening and closing torque curves in the memory of the EFS2000 and to transfer them to the torque curve reference registers. The old reference data are lost and the new ones will be the new torque curves reference (see View routines, Maintenance, Torque Curve).

Configuration procedure

- Move the local selector to OFF and then simultaneously press OPEN and STOP within 20 sec (see chapter 'Local controls, entering the set-up mode'). Select the language and enter the password according to the instructions (see 'Entering the set-up mode'). When the message displayed is 'SET-UP MODE OK?' press YES. Press NO to scroll through the list of available menus and then press YES to select the Maintenance menu.
- Press NO to scroll through the list of available routines and then press YES to select set curve reference.
- Press NO to scroll through the list and then press YES to select the desired curves (in opening and closing).
- Press YES to update the torque curve reference.

BIFFI FAIL SAFE ELECTRIC ACTUATORS, MODEL EFS2000V4

INSTRUCTION AND OPERATING MANUAL

13.3.5 Clear recent data log

The clear recent data log routine allows to clear the counters of the recent operation log. This command does not affect the content of the 'general operation log'. The date of the 'clear recent data log' is memorized and can be viewed in the maintenance date routine of the view menu.

Clear procedure

- Move the local selector to OFF and then simultaneously press OPEN and STOP within 20 sec (see chapter 'Local controls, entering the set-up mode'). Select the language and enter the password according to the instructions (see 'Entering the set-up mode'). When the message displayed is 'SET-UP MODE OK?' press YES. Press NO to scroll through the list of available menus and then press YES to select the Maintenance menu.
- Press NO to scroll through the list of available routines and then press YES to select clear recent data log.
- Press YES
- Press YES to clear or press NO to exit.

13.3.6 Set maintenance date

The maintenance date routine allows the following operations:

- To set the last maintenance date
- To set the next maintenance date
- To set the start-up date

Configuration procedure

- Move the local selector to OFF and then simultaneously press OPEN and STOP within 20 sec (see chapter 'Local controls, entering the set-up mode'). Select the language and enter the password according to the instructions (see 'Entering the set-up mode').

When the message displayed is 'SET-UP MODE OK?' press YES. Press NO to scroll through the list of available menus and then press YES to select the Maintenance menu.

- Press NO to scroll through the list of available routines and press YES to select maintenance date.
- Press YES to set the last maintenance date. Press NO to skip to 'next maintenance date'.

Last maintenance date

- Press YES if the date is correct, press NO to change it.
- Enter day, month, and year. Press NO to scroll through the list of available values, press YES to select.
- Press YES if the date is correct.

Next maintenance date

- Press YES if the date is correct, press NO to change it.
- Enter day, month, and year. Press NO to scroll through the list of available values, press YES to select.
- Press YES if the date is correct.

Start-up date

- Press YES if the date is correct, press NO to change it.
- Enter day, month, and year. Press NO to scroll through the list of available values, press YES to select.
- Press YES if the date is correct.

13.3.7 Set data logger

The 'data logger' routine allows to set the data logger parameters (see View routines, Maintenance, Data Logger). To start the data logger the following data should be set:

| | |
|---|---|
| <input type="checkbox"/> Logger mode: | Recorder, event, off, T-recorder |
| <input type="checkbox"/> Sampling time: | From 1 to 3600 secs (the sampling time is only used in recorder mode) |
| <input type="checkbox"/> Memory mode: | Stop when memory is full, continuous = stop after overwriting 5000 times (event) and 10000 times (recorder/T-recorder) the memory |
| <input type="checkbox"/> Logger mode: | Recorder, event, off, T-recorder |
| <input type="checkbox"/> Sampling time: | From 1 to 3600 secs (the sampling time is only used in recorder mode) |
| <input type="checkbox"/> Memory mode: | Stop when memory is full, continuous = stop after overwriting 5000 times (event) and 10000 times (recorder/T-recorder) the memory |
| <input type="checkbox"/> Start date: | Date when the logger starts |
| <input type="checkbox"/> Start time: | Time when the logger starts |
| <input type="checkbox"/> Start date: | Date when the logger starts |
| <input type="checkbox"/> Start time: | Time when the logger starts |

Configuration procedure

- Move the local selector to OFF and then simultaneously press OPEN and STOP within 20 sec (see chapter 'Local controls, entering the set-up mode'). Select the language and enter the password according to the instructions (see 'Entering the set-up mode'). When the message displayed is 'SET-UP MODE OK?' press YES. Press NO to scroll through the list of available menus and then press YES to select the Maintenance menu.
- Press NO to scroll through the list of available routines and then press YES to select 'data logger'.
- Press YES if the mode is correct. Press NO to scroll through the list of modes and press YES to select the desired value.
- Press YES if the sampling time is correct. Press NO to scroll through the list of times and press YES to select the desired value.
- Press YES if the memory mode is correct (stop when full or continuous). Press NO to change and press YES to select.
- Press YES if the start time is correct. Press NO to scroll through the list and press YES to select the desired sampling times (hour, min, sec).
- Press YES if the start date is correct. Press NO to scroll through the list and press YES to select the desired sampling times (day, month, year)
- Press YES to confirm the above settings.

13.3.8 Set PST reference

The 'Set PST reference' routine allows you to select 1 off 16 PST curves in the memory of the EFS2000 and to transfer its data to the PST curve reference registers. The old reference data are lost and the new ones will be the new PST curves reference (see 'View routines, Maintenance, PST graph').

Configuration procedure

- Move the local selector to OFF and then simultaneously press OPEN and STOP within 20 sec (see chapter 'Local controls, entering the set-up mode'). Select the language and enter the password according to the instructions (see 'Entering the set-up mode'). When the message displayed is 'SET-UP MODE OK?' press YES. Press NO to scroll through the list of available menus and then press YES to select the Maintenance menu.
- Press NO to scroll through the list of available routines and then press YES to select 'Set PST reference'.
- Press NO to scroll through the list and then press YES to select the desired curve.
- Press YES to update the PST curve reference.

13.3.9 PST commands(normal or baseline)

The PST CMD routine allows performing the PST cycle by the local operator interface of the actuator. Two options are available:

- New baseline
- Normal PST

If option 'new baseline' is chosen the data collected in the PST cycle are used to update the PST reference curve. If option 'normal' is chosen, the data collected in the PST cycle are stored in the EFS 2000 memory. Up to 16 PST curves can be memorized. When a new curve is achieved the oldest one is cancelled.

13.3.10 Set ESD reference

The 'Set ESD reference' routine allows you to select 1 off 16 ESD curves in the memory of the EFS2000 and to transfer its data to the ESD curve reference registers. The old reference data are lost and the new ones will be the new ESD curves reference (see 'View routines, Maintenance, EFS graph').

Configuration procedure

- Move the local selector to OFF and then simultaneously press OPEN and STOP within 20 sec (see chapter 'Local controls, entering the set-up mode'). Select the language and enter the password according to the instructions (see 'Entering the set-up mode'). When the message displayed is 'SET-UP MODE OK?' press YES. Press NO to scroll through the list of available menus and then press YES to select the Maintenance menu.
- Press NO to scroll through the list of available routines and then press YES to select 'Set ESD reference'.
- Press NO to scroll through the list and then press YES to select the desired curve.
- Press YES to update the ESD curve reference.

13.3.11 Example of set-up routine: Torque set-up

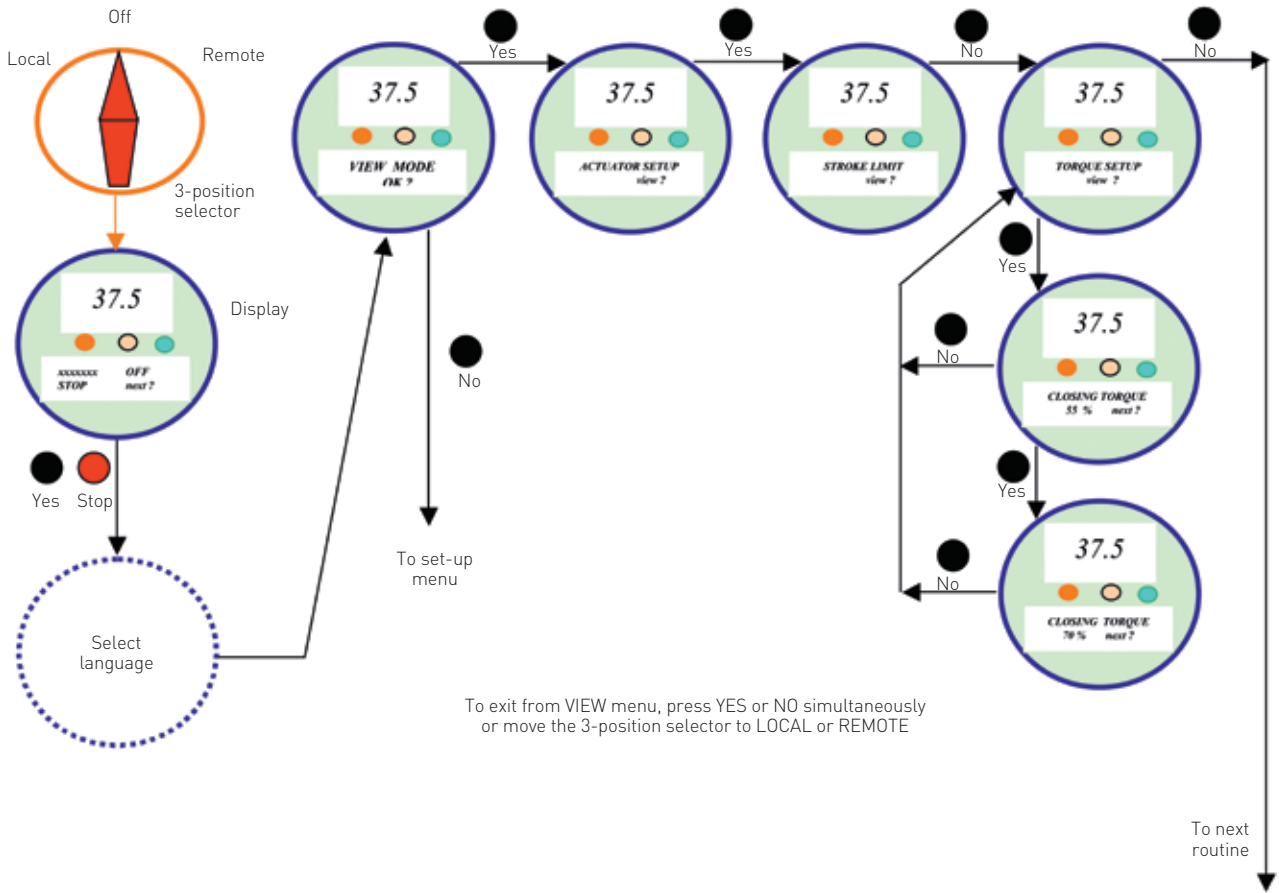

BIFFI FAIL SAFE ELECTRIC ACTUATORS, MODEL EFS2000V4

INSTRUCTION AND OPERATING MANUAL

14 VIEW ROUTINES

14.1 Actuator set-up

The above menu allows viewing the present actuator configuration. No change can be made to the present data. The following data can be viewed:

| Routine | Parameters |
|-------------------|--|
| • Stroke limits | • Close limit type (torque or position), open limit type (torque or position) |
| • Torque set-up | • Closing torque limit %, opening torque limit % |
| • EFS setup | • EFS and PST parameters |
| • Remote controls | • Control type |
| • Local controls | • Control type, LED's color |
| • Output relays | • Monitor relay conditions, ASi conditions, contact action |
| • Positioner* | • Dead band, motion inhibit time, polarity, %min, %max (%min and %max are present only if 'position request R%' is from 4-20 mA input) |
| • Failsafe* | • Action, delay |
| • Out 4-20 mA* | • Output signal (position or torque), polarity |
| • Interlock | • Signal type in OP, signal type in CL |
| • 2-speed timer | • Close direction: status, start, stop, on time, off time • Open direction: status, start, stop, on time, off time |
| • Bus* | • Node address, terminations, etc. depending on fieldbus type |
| • Miscellaneous | • Time and date, torque mode, lithium battery, torque by pass %, valve jammed time |

The routines with * can only be viewed if the relevant electronic cards are present. If the bus interface is LonWorks, routine 'Bus' changes to 'FDI control'.

Detailed descriptions of the above routines and their parameters can be found in Chapter 'Set-up routines'.

View procedure

- Move the local selector to OFF and then simultaneously press OPEN and STOP within 20 sec (see chapter 'Local controls, entering the set-up mode'). Select the language according to the instructions (see 'Entering the set-up mode'). When the message displayed is 'SET-UP MODE OK?' press YES. Press YES to select the Actuator set-up menu.
- Press NO to scroll through the list of available routines and press YES to select.
- Press YES to answer at the prompt 'view' or 'next' and to see the data.

14.2 Name plate

Use this menu to view the data identifying the actuator. The data are entered in-house and can only be changed by the manufacturer. The following data may be viewed:

- Serial number: max. 28 characters, univocal identifier of the actuator by reference to BIFFI acknowledgment.
- Actuator type: max. 28 characters, describes the type of actuator with reference to BIFFI catalog.
- Torque/thrust: nominal torque or thrust of actuator
- Actuator speed: nominal speed of actuator.
- Power supply: nominal voltage and frequency of actuator.
- Motor data: includes the following data relevant to the electrical motor:
 - Power type (3ph, 1ph, dc).
 - Power rating, max. 99.9 KW.
 - In, max. 99.9 A.
 - Is, max. 99.9 A.
 - Icc, max 999.9 A.
 - Duty (S2/15 min, etc.).
 - Poles (2, 4, etc.).
 - Biffi name, max 28 characters.
 - Gear ratio, max 1000.
 - Test date: date of the in-house functional test of actuator.
- Wiring diagram (WD): wiring diagram number, max 28 characters.
- Enclosure: type of enclosure (Eex-d, etc), max 28 characters.
- Certificate: number of certificate, max. 28 characters.
- Lubricant: type of lubricant, max. 28 characters.
- Revision: HW revision of base card, SW revision of H8 microprocessor, SW revision of PIC microprocessor.
- Torque sensor: data relevant to the relationship between motor torque and speed. This set of data contains also the factory torque limit setting, 'Torque-set CL' and 'Torque-set OP'.

View procedure

- Move the local selector to OFF and then simultaneously press OPEN and STOP within 20 sec (see chapter 'Local controls, entering the set-up mode'). Select the language and enter the password according to the instructions (see 'Entering the set-up mode'). When the message displayed is 'SET-UP MODE OK?' press YES. Press NO to scroll through the list of available menus and then press YES to select the Nameplate menu.
- Press YES to answer the prompt 'view' or 'next' and see the data in the above list.

14.3 Valve data

To identify the valve and its function in the process the following data can be viewed.

- Tag name (max. 28 char.)
- Serial number (max. 28 char.)
- Manufacturer (max. 28 char.)
- Break-OP torque (max. 28 char.)
- Break-CL torque (max. 28 char.)
- Max stem thrust (max. 28 char.)
- Flange type(max. 28 char)

The data should be entered by the valve manufacturer or by the end user during set-up operations.

View procedure

- Move the local selector to OFF and then simultaneously press OPEN and STOP. Select the language according to the instructions (see 'Entering the view mode'). When the message displayed is 'VIEW MODE OK?' press YES. Press NO to scroll through the list of available menus and press YES to select the Valve data menu.
- Press YES to answer prompts 'view' or 'next' and see the data in the above list.

14.4 Maintenance

14.4.1 Alarm log

The alarm log routine is used to view the list of the latest 64 alarms and 64 warnings and the data when they occurred. The 'clear alarm log' routine of the set-up menu should be used to clear the list.

View procedure

- Move the local selector to OFF and then simultaneously press OPEN and STOP within 20 sec (see chapter 'Local controls, entering the view and set-up mode'). Select the language according to the instructions (see 'Entering the view mode'). When the message displayed is 'VIEW MODE OK?' press YES. Press NO to scroll through the list of available menus and then press YES to select the Maintenance menu.

- Press YES to answer the prompt 'Alarm log view?'
- Press YES to scroll through the list of alarms ('Alarms view?').
- Press NO to move on to 'Warnings view?' and then YES to scroll through the list of warnings.

14.4.2 Torque profile

The torque profile routine gives important information on the actuator working conditions in comparison with a previously memorized reference profile. It can give a summarized but significant indication of a change in the process conditions.

Details are given of the reference and latest torque expressed in percentage of the nominal torque.

At the end of a full stroke in opening or closing, the ICON2000 stores the 3 maximum torque values in position intervals 0%-10%, 10%-90%, 90%-100% in opening, and the 3 maximum torque values in position intervals 100%-90%, 90%-10%, 10%-0% in closing. Time and date of strokes are also saved. The above data are updated at the end of every full valve stroke and the previous ones are lost. Function 'set torque reference', in the Set-up menu, Maintenance, (Chapter I), allows saving the 'torque profile' data in the 'torque profile reference' with date and time. The 'torque profile reference' will not be updated until a new 'set torque reference' command is entered. The user can compare the last torque profile relevant to the last valve stroke with the torque profile reference saved before. The following definitions will be used:

- Breakout: maximum torque percentage in position interval 0-10% in opening or 100%-90% in closing = maximum percentage of torque to unseat the valve.
- Peak Running: maximum torque percentage in position interval 10-90% in opening or 90%-10% in closing = maximum percentage of torque when the valve runs from Breakout to Ending (maximum mid travel).
- Ending: maximum torque percentage in position interval 90-100% in opening or 10%-0% in closing = maximum percentage of torque to seat the valve.

BIFFI FAIL SAFE ELECTRIC ACTUATORS, MODEL EFS2000V4

INSTRUCTION AND OPERATING MANUAL

The following data may be viewed:

| Closing torque | Opening torque |
|-------------------------------------|-------------------------------------|
| Breakout % | Breakout % |
| Breakout reference % | Breakout reference % |
| Peak run % | Peak run % |
| Peak run reference % | Peak run reference % |
| Ending % | Ending % |
| Ending reference % | Ending reference % |
| Date of the last stroke | Date of the last stroke |
| Date of reference (same as opening) | Date of reference (same as closing) |

View procedure

- Move the local selector to OFF and then simultaneously press OPEN and STOP within 20 sec (see chapter 'Local controls, entering view and set-up mode'). Select the language according to the instructions (see 'Entering the view mode'). When the message displayed is 'VIEW MODE OK?' press YES. Press NO to scroll through the list of available menus and press YES to select the Maintenance menu.
- Press NO to scroll through the list of routines and press YES to select torque profile.
- Press YES to scroll through the list of values.

14.4.3 Torque curve

The torque curve routine gives important information on the actuator operating conditions in comparison with a previously memorized reference torque curve. It can be used to perform a detailed analysis of a change in the process conditions. During a full valve stroke in opening or closing, the ICON2000 measures the torque values relevant to every 1% of position variation. At the end of the stroke the collected 101 values (one torque value every 1% of position change) are saved in the ICON2000 memory together with the time and date of strokes, main voltage, motor temperature, temperature inside the electronics compartment and temperature inside the terminal board compartment. Up to 100 curves in opening and 100 curves in closing can be saved. When a new curve is available the oldest one is cancelled and the new one is memorized. The above data are updated at the end of every full valve stroke. Data relevant to a partial stroke are discharged.

The function 'set curve reference', in the Set-up menu, Maintenance (chapter I), allows saving the full set of data relevant to 1 off 100 'torque curves' in the 'torque curve reference'. The 'torque curve reference' will not be updated until a new 'set curve reference' command is entered. The user can compare the last 100 torque curves in opening and closing relevant to the last 200 valve strokes with the torque curve reference saved before.

Below is the list of saved data for each opening or closing curve:

- Date: date of the valve stroke
- Time: time of the valve stroke
- Temperature: temperature (°C) inside the electronics compartment during the valve stroke
- Term. temp: temperature (°C) inside the terminal board compartment during the valve stroke
- Motor temp: temperature of the electrical motor (°C) during the valve stroke
- Main voltage: main voltage supply (V) during the valve stroke
- Closing/Opening time
- Torque 0: torque value in percentage of the nominal torque/thrust stated in the Nameplate menu. In opening 'Torque 0' corresponds to position 0% and in closing 'Torque 0' corresponds to position 100%
- Torque 100: torque value in percentage of the nominal torque/thrust stated in the Nameplate menu. In opening 'Torque 100' corresponds to position 100% and in closing 'Torque 100' corresponds to position 0%

The amount of data to be viewed is large and the local display can only visualize one value at a time. To use this function we suggest utilizing the features available with PDA's and PC through Bluetooth® wireless connection. The figure below shows an example of graph available on PDA or PC screen, showing the reference opening torque curve and the latest opening torque curve.

BIFFI FAIL SAFE ELECTRIC ACTUATORS, MODEL EFS2000V4

INSTRUCTION AND OPERATING MANUAL

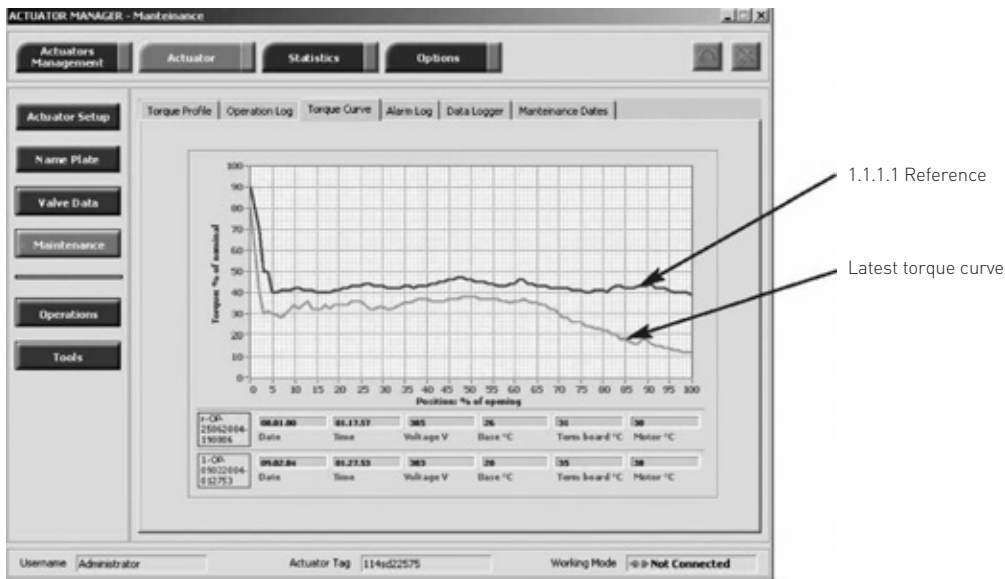

View procedure

- Move the local selector to OFF and then simultaneously press OPEN and STOP within 20 sec (see chapter 'Local controls, entering view and set-up mode'). Select the language according to the instructions (see 'Entering the view mode'). When the message displayed is 'VIEW MODE OK?' press YES. Press NO to scroll through the list of available menus and press YES to select maintenance menu.
- Press NO to scroll through the list of routines and press YES to select torque curve.
- Press NO to scroll through the list of available curves (from 1 to 5 and reference). Curve 1 is the latest and curve 5 is the oldest. Press YES to select.
- Press YES to select the opening or closing curve. Press NO to exit.
- Press YES to scroll through the list values. Press NO to exit.

14.4.4 Operation log

The operation log consists of different counters and routines that provide information to assist in the maintenance program.

The data are grouped into 2 families: general and recent data. The general data log collects data from 'test date' to 'present date'. The test date is set in house, can be viewed in the 'name plate' menu but cannot be changed. The recent data log collects data from the last 'clear recent data log' date to 'present date'. A command 'clear recent data log' is available in the Set-up menu, maintenance (chapter I). This command clears the content of the recent data log and resets the counters to 0. The old data are lost.

The main differences between 'general' and 'recent' data log are the following:

- The general data log gives information relevant to the full life of the actuator, starting from the manufacturing date.
- In the recent data log the same data are collected starting from a date set by the user. The date may be viewed in the 'Maintenance date' paragraph.

Below is the list of data collected by the general and recent data log.

| General data log | Recent data log |
|-------------------|-------------------|
| Opening time | |
| Closing time | |
| Contactor cycles | Contactor cycles |
| Motor run time | Motor run time |
| No power time | No power time |
| Utilization rate | Utilization rate |
| Temperature min. | Temperature min. |
| Temperature max | Temperature max |
| Term temp min. | Term temp min. |
| Term temp max. | Term temp max. |
| Motor temp max. | Motor temp max. |
| Thermostat alarms | Thermostat alarms |
| Torque alarms | Torque alarms |

- Opening time: this information is only available in the general data log. It is updated at the end of every full valve stroke of the valve in opening direction. The data of the previous stroke are lost. It gives the time necessary to the valve to move from the close position to the open position, expressed in hours, minutes and seconds.
- Closing time: this information is only available in the general data log. It is updated at the end of every full valve stroke of the valve in closing direction. The data of the previous stroke are lost. It gives the time required to move the valve from the open position to the close position, expressed in hours, minutes and seconds.
- Contactor cycles: this number represents the amount of cycles of contactors K1 and K2. The value indicated in the general data log is also used to generate the 'maximum contactor cycles' warning when the maximum allowable number of cycles of the contactor is reached (see paragraph 12.11 of document BIFRM-0003-EN). If the main power is DC or single phase and in modulating actuators, the counters (general and recent) are hold to 0.
- Motor run time: this parameter counts the hours with motor energized.
- No power time: this parameter counts the hours without electrical power.
- Utilization rate: this value is incremented every 200 full strokes of the actuator. It reaches 100% after 20.000 full strokes.
- Temperature min.: this is the lowest temperature value (in °C) measured inside the electronics compartment.
- Temperature max.: this is the highest temperature value (in °C) measured inside the electronics compartment.
- Term. temp. min.: this is the lowest temperature value (in °C) measured inside the terminal board enclosure.
- Term. temp. max.: this is the highest temperature value (in °C) measured inside the terminal board enclosure.
- Motor temp. max.: this is the highest temperature value (in °C) measured in the electrical motor.
- Thermostat alarms: this counter represents the number of alarms due to the high temperature of the electrical motor and to the tripping of the motor thermostat.
- Torque alarms: this counter represents the number of alarms due to high torque in opening and closing.

View procedure

- Move the local selector to OFF and then simultaneously press OPEN and STOP within 20 sec (see chapter 'Local controls, entering view and set-up mode'). Select the language according to the instructions (see 'Entering the view mode'). When the message displayed is 'VIEW MODE OK?' press YES. Press NO to scroll through the list of available menus and press YES to select the Maintenance menu.
- Press NO to scroll through the list of available routines and press YES to select operation log.
- Press YES to select general data or press NO to skip to recent data.
- Press YES to scroll through the list of values.
- Press YES to view the recent data log or press NO to exit.
- Press YES to scroll through the list of values.

14.4.5 Maintenance date

The routine allows viewing the following dates:

- Last date
 - Next date
 - Start-up date
 - Recent log date
-
- Last date: this is the date of the last maintenance operation. The date should be updated by the user after each maintenance operation (see 'Set-up routines', maintenance, chapter 'Set maintenance date').
 - Next date: this is the date of the next scheduled actuator maintenance. When the date is reached, the EFS2000 generates a maintenance request warning. The date should be updated by the user after all maintenance operations (see Set-up menu, maintenance, chapter I).
 - Start-up date: this is the date of actuator start-up. During commissioning, the user should enter the start-up date (see Set-up menu, maintenance, chapter I).
 - Recent log date: This is updated after entering command 'Clear recent data log' (see Set-up menu, maintenance, chapter I). This command clears the 'recent data log' counters. The content of 'recent log' is updated starting from 'recent log date'.

BIFFI FAIL SAFE ELECTRIC ACTUATORS, MODEL EFS2000V4

INSTRUCTION AND OPERATING MANUAL

View procedure

- Move the local selector to OFF and then simultaneously press OPEN and STOP within 20 sec (see chapter 'Local controls, entering view and set-up mode'). Select the language according to the instructions (see 'Entering the view mode'). When the message displayed is 'VIEW MODE OK?' press YES. Press NO to scroll through the list of available menus and press YES to select the Maintenance menu.
- Press NO to scroll through the list of available routines and press YES to select the maintenance date routine.
- Press YES to scroll through the list of dates.

14.4.6 Data logger

The 'data logger' routine allows the user to collect different types of data that could be useful in maintenance or in diagnostic programs. Since the amount of collected data is very large, the data logger can only be viewed by means of a PDA or PC. The data can be up-loaded from EFS2000 to PDA or PC by the Bluetooth® wireless connection. The local display only allows to view the value of the configured parameters (see also SET-UP menu, Maintenance, Set data logger, chap I).

The following data can be viewed on the local display:

- Logger mode
- Sampling time
- Memory mode
- Date
- Time

Data logger modes:

- OFF: the data logger is not active.
- RECORDER mode: the EFS2000 measures and memorizes the following 3 data:
 - Main voltage supply (V)
 - Motor temperature (°C)
 - Temperature inside the compartment of electronics (°C)

- T-RECORDER mode: the ICON2000 measures and memorizes the following 3 data:
 - Torque in OP/CL
 - Motor temperature (°C)
 - Voltage

In RECORDER and T-RECORDER mode the 'Sampling time' fixes the time interval among two sets of measurements. A maximum of 1024 data points (equivalent to 256 x 4 samples) can be memorized. The sampling time can be configured from 1 to 3600 seconds. START DATE and START TIME fix date and time to start recording operation. When the memory is full, the recorder stops recording or overwrites the previous data according to the selected MEMORY MODE ('stop when full' or 'continuous'). If 'continuous' was selected, a new set of measured values overwrites the previous one and the old data is lost. Up to 10.000 cycles of full memory overwriting are done, then the recorder stops.

In T-RECORDER mode, recording operation is stopped also in case of an over-torque alarm, in opening or in closing direction. This additional feature allows memorizing the last 256 samples and to see the trend of torque, motor temperature and main voltage just before the alarm. A new restart of T-RECORDER clears the data stored in the memory.

By a PDA or PC the recorded data can be viewed in a graph where time is on the X-axis and the measured data on the Y-axis. The figure below shows a graph with sampling time 2 seconds in RECORDER mode.

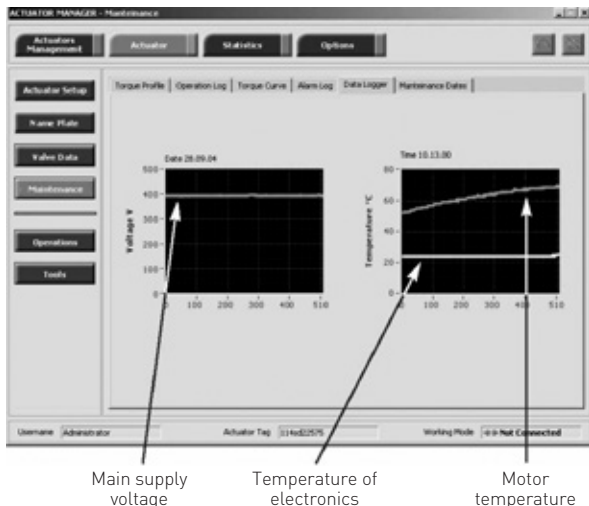

BIFFI FAIL SAFE ELECTRIC ACTUATORS, MODEL EFS2000V4

INSTRUCTION AND OPERATING MANUAL

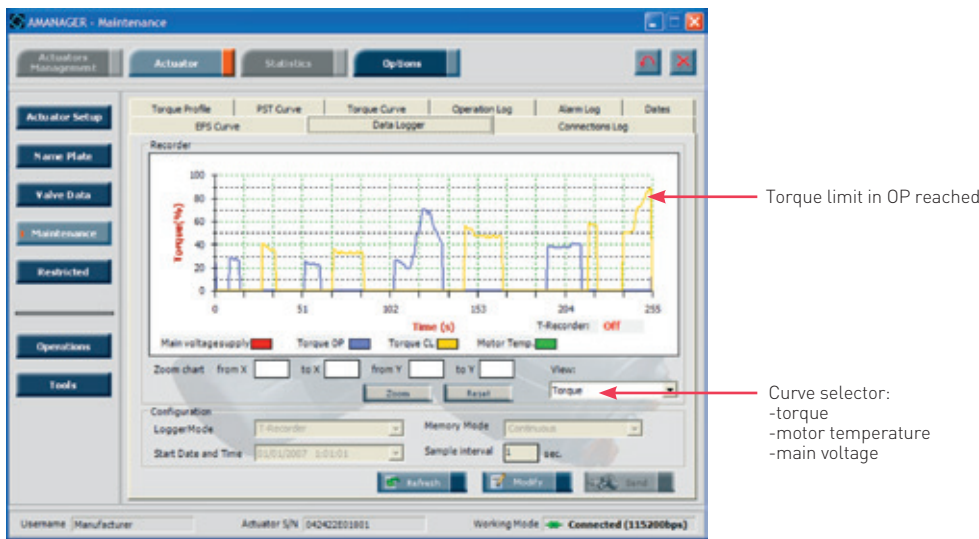

The figure below shows a graph with sampling time 1 sec in T-RECORDER mode after a recording stop due to over-torque alarm. Torque limit in CL is set to 90%; torque limit in OP is set to 100%. Blue graph shows Torque OP versus time, yellow graph shows Torque CL versus time. The data remains in the EFS2000v4 permanent memory until a new start of data logger is set.

Up to 5.000 cycles of full memory overwriting are allowed, then the logger stops. The START DATE and START TIME fix date and time to start recording operation. By a PDA or PC the collected data can be viewed in a graph or event table. Parameter 'sampling time' is not used. The figure below shows an example of report in event mode.

- Press YES to view the MODE, the SAMPLING time, the MEMORY mode, the start DATE and the start TIME.
- Press YES to return data logger. Press NO to exit.

- Event mode
The ICON2000 detects the type of received command (OPEN or CLOSE), the source of the command (local controls, remote controls, bus, etc.) and date and time of command. Up to 128 events can be memorized. When the memory is full, the logger stops memorizing the events or overwrites the previous data according to the selected 'Memory mode' ('stop when full' or 'continuous'). If 'continuous' was selected, the latest event will overwrite the oldest event.

View procedure

- Move the local selector to OFF and then simultaneously press OPEN and STOP within 20 sec (see chapter 'Local controls, entering view and set-up mode'). Select the language according to the instructions (see 'Entering the view mode'). When the message displayed is 'VIEW MODE OK?' press YES. Press NO to scroll through the list of available menus and press YES to select maintenance menu.
- Press NO to scroll through the list of routines and press YES to select data logger.

| Date | Time | CMD | Source |
|------------|----------|-----|--------|
| 23/11/2004 | 9.39.46 | CP | local |
| 23/11/2004 | 10.11.11 | CL | local |
| 23/11/2004 | 11.11.23 | CP | local |
| 23/11/2004 | 14.11.40 | CL | local |
| 24/11/2004 | 2.12.00 | CL | remote |
| 24/11/2004 | 7.12.12 | CP | ESD |
| 24/11/2004 | 11.12.53 | CP | remote |
| 24/11/2004 | 13.13.19 | CL | remote |
| 24/11/2004 | 14.13.23 | CL | remote |
| 24/11/2004 | 15.13.35 | CP | remote |
| 24/11/2004 | 16.13.57 | CL | local |

BIFFI FAIL SAFE ELECTRIC ACTUATORS, MODEL EFS2000V4

INSTRUCTION AND OPERATING MANUAL

14.4.7 Example of view routine: Torque set-up

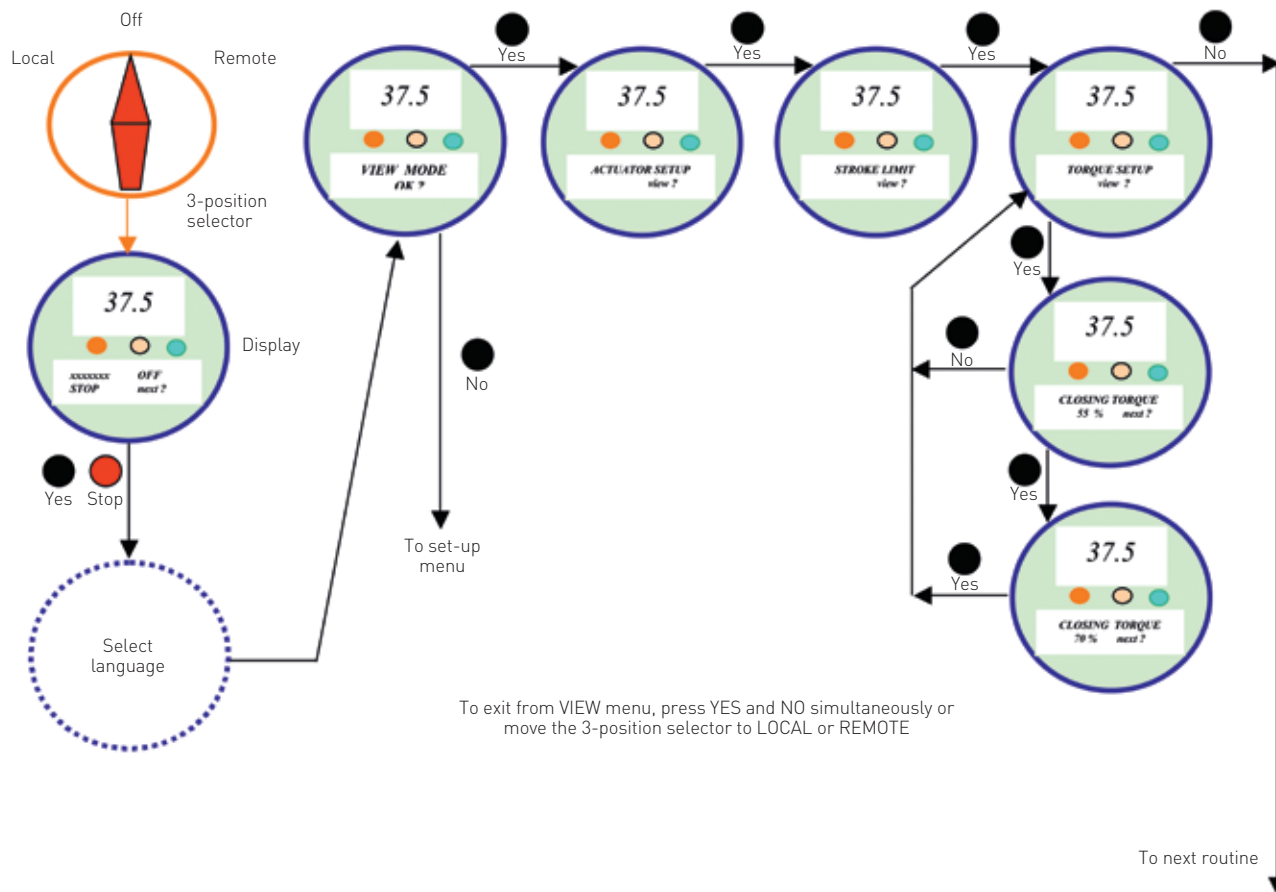

BIFFI FAIL SAFE ELECTRIC ACTUATORS, MODEL EFS2000V4

INSTRUCTION AND OPERATING MANUAL

14.4.8 PST Graph

The PST curves cannot be viewed on the local operator interface of the EFS2000. They can only be viewed by a PC or PDA connected by a Bluetooth® interface and equipped with the A-manager software tool.

The following figure shows the data available.



AMANAGER - PST Curve Details

| PST Curves | | Temperatures (°C) | | Motor | EFS | PST Result | Voltage (V) | Select Ref. | |
|------------|---------------------|-------------------|-------|-------|-----|------------|--------------|-------------|-----------------------|
| Date | Time | Length | Elct. | | | | | | Term. |
| Curve 016 | 01/01/2000 00:53:36 | 28,7 s | 25 | 25 | 24 | 37 | Failed OV-TR | 400 | <input type="radio"/> |
| Curve 015 | 01/01/2000 00:51:07 | 30,4 s | 25 | 25 | 23 | 37 | Passed | 400 | <input type="radio"/> |
| Curve 014 | 27/01/2000 22:14:00 | 23,3 s | 29 | 29 | 27 | 49 | Passed | 396 | <input type="radio"/> |
| Curve 013 | 27/01/2000 22:12:43 | 22,8 s | 29 | 28 | 26 | 48 | Passed | 394 | <input type="radio"/> |
| Ref. Curve | 01/01/2000 00:50:04 | 29,2 s | 25 | 25 | 23 | 37 | Passed | 400 | <input type="radio"/> |

Buttons: Set ref curve, Back

BIFFI FAIL SAFE ELECTRIC ACTUATORS, MODEL EFS2000V4

INSTRUCTION AND OPERATING MANUAL

14.4.9 ESD Graph

The ESD curves cannot be viewed on the local operator interface of the EFS2000. They can only be viewed by a PC or PDA connected by a Bluetooth® interface and equipped with the A-manager software tool.

The following figure shows the data available.

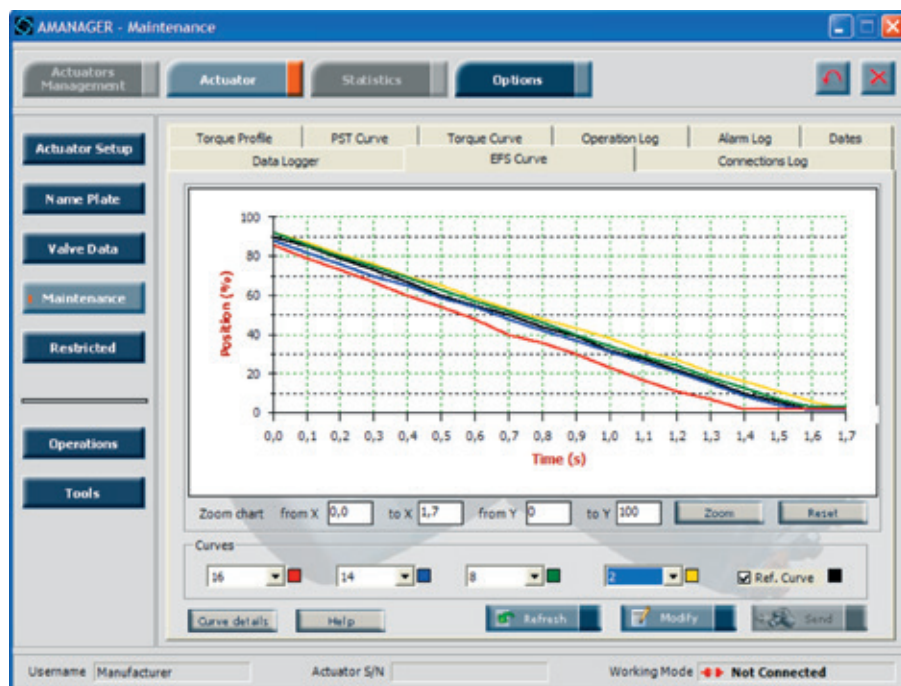

AMANAGER - EFS Curve Details

| EFS Curves | Date | Time | Length | Temperatures (°C) | | | | Voltage (V) | Select Ref. |
|------------|------------|----------|--------|-------------------|-------|-------|-----|-------------|-----------------------|
| | | | | Elet. | Term. | Motor | EFS | | |
| Curve 016 | 01/01/2000 | 00:16:11 | 1,5 s | 25 | 25 | 23 | 29 | 398 | <input type="radio"/> |
| Curve 014 | 29/01/2000 | 01:20:31 | 1,7 s | 32 | 30 | 25 | 51 | 399 | <input type="radio"/> |
| Curve 008 | 22/01/2000 | 02:15:10 | 1,7 s | 32 | 28 | 26 | 38 | 396 | <input type="radio"/> |
| Curve 002 | 16/04/2007 | 08:59:05 | 1,8 s | 28 | 28 | 25 | 37 | 401 | <input type="radio"/> |
| Ref. Curve | 09/02/2000 | 00:52:23 | 1,7 s | 29 | 27 | 23 | 38 | 401 | |

Buttons: Set. ref. curve, Back

BIFFI FAIL SAFE ELECTRIC ACTUATORS, MODEL EFS2000V4

INSTRUCTION AND OPERATING MANUAL

15 LOCAL INDICATOR SETTING

Move the EFS2000v4 to the fully closed position



1. Remove the black plug

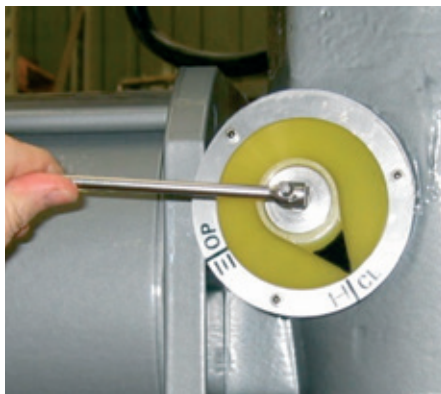

2. Unscrew the central screw

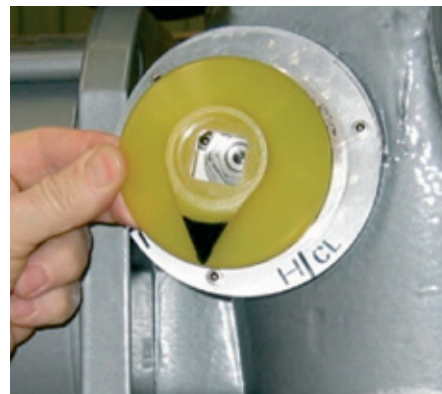

3. Remove the indicator

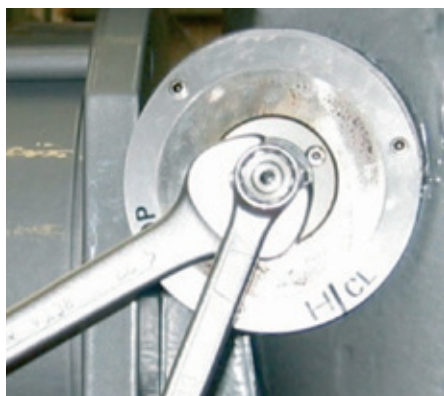

4. Unloose the counter nut



5. Rotate the indicator nut clockwise until it blocks at the end of the threads; rotate a few degrees counter clockwise until the flat surface is perfectly aligned with the CLOSE indication of the label.



6. Fix the counter nut

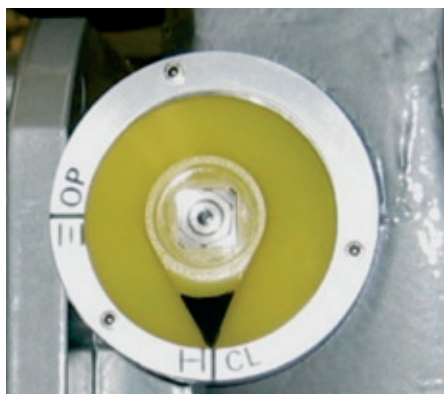

7. Replace the indicator, with the arrow corresponding to the CLOSE indication on the label



8. Fix the central screw



9. Replace the plug

16 MANUAL OPERATION AND FAILSAFE SPEED SETTING

16.1 Hydraulic control group diagram

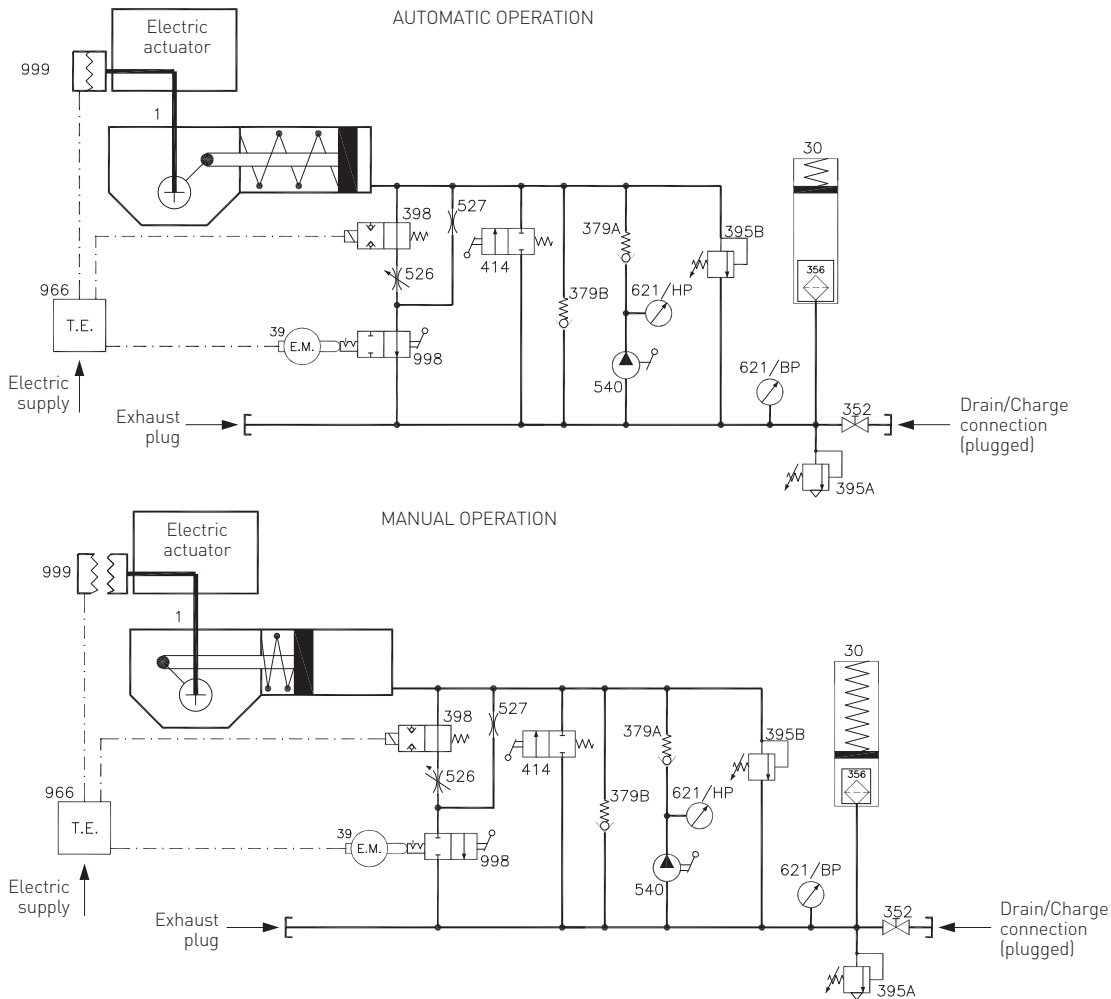

Emergency closing operation

In case of electric supply failure, the electro-magnetical latch opens and the actuator moves the valve in closing position by a spring.

Failsafe time regulation

The closing time is adjustable by the flow regulator 526.

Local manual operation to open

In case of loss of electric supply, switch the valve 998 in manual mode and actuate the hand pump 540 to open the actuator.

Local manual operation to close

With valve 998 in 'manual' position, press the lever of hydraulic push button 414, the actuator moves in closing position by a spring.

Notes

1. The diagram in shown for spring to close actuator.

- 1 Single acting spring return hydraulic actuator
- 30 Hydraulic accumulator (piston type/spring return)
- 39 Selector position micro switch
- 352 Needle valve
- 356 Hydraulic filter
- 379 Check valve
- 395 Safety relief valve
- 398 N.O. poppet type solenoid valve (optional)
- 414 2/2 N.C. hand operated-spring return valve
- 526 Bidirectional flow regulator (adjustable setting)
- 527 Bidirectional flow regulator
- 540 Hand pump
- 621 Pressure gauge
- 966 Terminals enclosure
- 998 2/2 N.C. hand selector (auto/manual)
- 999 Electro magnetical latch

Remove the cover



Adjust the fail safe speed



16.2 Control group functions

The EFS2000v4 is equipped with a hydraulic Control group with two base functions:

- Adjustment of failsafe time.
- Manual override to operate the actuator when electrical power is not available.

16.2.1 Adjustment of failsafe time

The adjustable flow control valve (526) allows you to adjust the failsafe speed. This valve is located under the aluminium cover positioned on the upper side of the hydraulic manifold. Remove the cover by unscrewing the 2 screws in order to regulate the flow control valve: by turning the ring nut of the valve clockwise, the fail-safe speed decreases.

IMPORTANT

The failsafe time should not exceed the electric stroke time.

A longer failsafe time will trigger the torque alarm intervention on the electronic control of the electric actuator.

16.2.2 Manual override to operate the EFS2000v4 when electrical power is not available

When electric power is not available, the EFS2000v4 can be locally operated through an hydraulic hand pump (540).

Before operation of the hand-pump, it is required that the electromagnetic clutch is not energized: press the OFF push button (red mushroom) on the clutch to de-energize it.

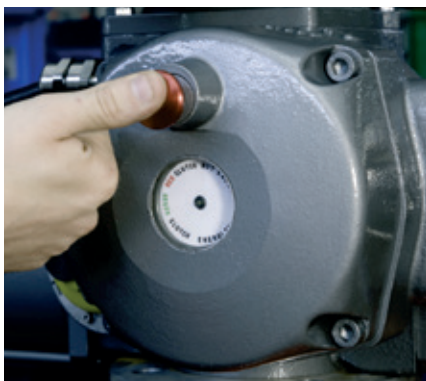

To select the MANUAL operation mode of the actuator, rotate the two-position (AUTO/MANUAL) hydraulic local selector (998).

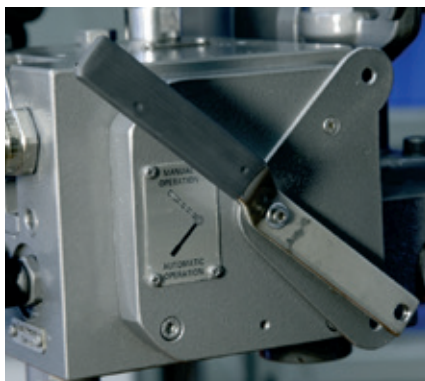

BIFFI FAIL SAFE ELECTRIC ACTUATORS, MODEL EFS2000V4

INSTRUCTION AND OPERATING MANUAL



Hand pump
High pressure manometer

WARNING!

For safety reasons it is required that at the end of operation by hand pump, the lever is removed from the hand pump yoke and the yoke is fixed using the existing split pin.

If at the end of a manual operation, the actuator is required to remain in the energized position, it is necessary to leave the hydraulic selector in MANUAL position.

To restore the electric mode function, the hydraulic selector has to be moved to AUTO position and, as soon the electrical power is available, the red mushroom push-button has to be pressed to RESET the actuator.

16.2.3 Accumulator recharge

The actuator is supplied with the accumulator (30) charged at a 3 bar pressure, with the main spring in its released position (failsafe condition).

If it is necessary to recharge the accumulator during or after the field installation, or after a maintenance intervention, the following instructions have to be performed:

- Check if the actuator is really in failsafe condition, with the main spring released; press the RED mushroom push button to ensure that the actuator is in the correct position.

- Check that the needle valve (352) is completely closed.
- Remove the drain/charge plug (P) by unscrewing it.
- Connect a 1/4" NPT hose to the drain/charge hole, and fill the oil until the low pressure manometer (621/BP) reaches a 3 bar pressure.
- Open the needle valve (352).
- During the refill with oil, it is possible that air is introduced inside the accumulator: this air has to be leaked using the two leaking plugs on the upper part of the manifold.
- Close the needle valve (352).
- Remove the 1/4" NPT hose and close the drain/charge hole with the drain/charge plug (P).

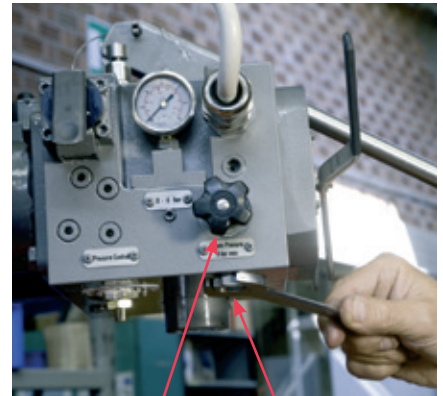

Needle valve (352)
Drain/charge plug

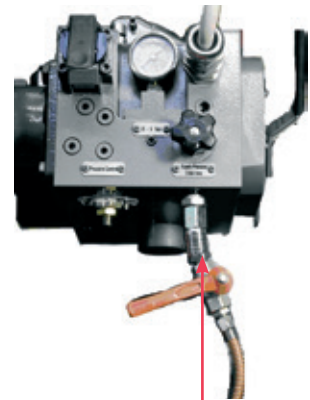

1/4" NPT hose

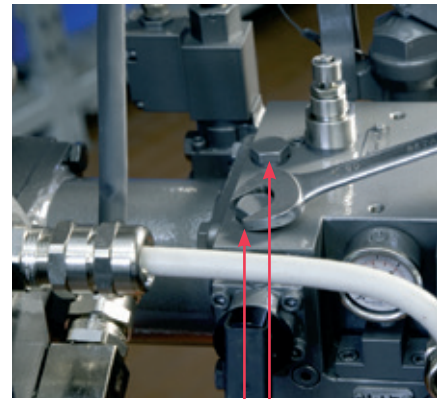

Purge Plugs

17 MAINTENANCE AND TROUBLE SHOOTING

WARNING!

The EFS2000v4 contains parts with springs, which can be compressed.

Before any disassembling, all precautions must be taken in order to ensure that the main power spring is fully released and the spring accumulator is fully discharged.

WARNING!

The actuator is non-intrusive. The control compartments are sealed in dry and clean conditions and contain no site serviceable components. Do not open it unless absolutely necessary. Unauthorized access will invalidate the warranty.

WARNING!

Since the actuator control compartment contains a 3.6V lithium battery, only open it in a safe area. If the actuator is located in a hazardous area, a 'hot work' permit must be obtained unless the actuator can be transported to a non-hazardous area.

IMPORTANT

To ensure the safety of the maintenance staff, it is essential to move the actuator to a failsafe position before carrying out any maintenance operation and disconnect both the actuator electrical power, the ESD line and any other service voltage connected to the terminal board.

17.1 Routine maintenance

It is mandatory to check the actuator, with a maximum interval of one year, as follows:

- Check that the actuator operates the valve correctly and within the required operating times.
- Check the ESD operation.
- Check that the signals to the remote control desk are correct.
- Check that the external components of the actuator are in good condition.
- Check the paint-coat of the actuator. If some areas are damaged, repair the paint-coat according to the applicable specification.

17.2 Special maintenance

In case of malfunction in the mechanical/ electronic components, in case of oil leaks through the seals or in case of scheduled preventive maintenance, the actuator must be disassembled: all damaged parts can be ordered from Biffi with reference to attached exploded view drawing and part list. When ordering spare parts, please provide the actuator serial number together with the item number of the components.

IMPORTANT

After maintenance, the actuator has to be stroked a couple of times to verify that the operation is normal, the stroke movements are regular and that there is no oil leakage through the seals.

BIFFI FAIL SAFE ELECTRIC ACTUATORS, MODEL EFS2000V4

INSTRUCTION AND OPERATING MANUAL

17.3 Repairs

When needed, repair must only be carried out with Manufacturer's original spare parts.

WARNING!

The values of gaps of explosion-proof joints are lower than the maximum specified on Tables 1 and 2 of IEC/EN 60079-1 Standard. In case the maintenance should require the replacement of any component which forms part of an explosion-proof joint, only an original spare provided by BIFFI MUST be used. Direct repair or reconstruction of the above components are not permitted without the BIFFI permission. Not performing this procedure will invalidate the product safety and contractual guarantee.

Original spare parts must be required to the Manufacturer: to ensure that right spare is provided, serial number printed on the EFS 2000v4 unit enclosure label must be specified when spares are ordered.

17.4 Lithium battery change

Isolate the main supply to the actuator and all other control voltages.

WARNING!

If the actuator is located in a hazardous area a "hot work" permit must be obtained unless the actuator can be moved to a non-hazardous area.

- Open the terminal board cover



- Disconnect two wires (+) (-) from the main board
- Bring the cover to a safe area. When in a safe area:

- Remove the label



- Remove the battery cover



- Replace the battery

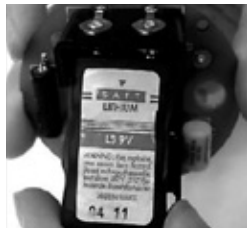

IMPORTANT

The new battery must be the same as the one provided:

- Lithium - SAFT LS 9V

BIFFI FAIL SAFE ELECTRIC ACTUATORS, MODEL EFS2000V4

INSTRUCTION AND OPERATING MANUAL

17.5 Trouble-shooting

If the actuator does not work before trouble-shooting make sure that:

- The numeric display indicates xx.x %
- The LED of EFS card in the clutch compartment is green
- The manual override selector is in AUTO
- The local selector is not in OFF
- The main supply voltage is the same as stated in the name plate menu
- The supply of the EFS clutch is in the range 24 Vdc -240 Vac
- Move the local selector to OFF and check that the upper line of the alphanumeric display shows one of the following messages:
 - 'normal off'
 - 'alarm off'
 - 'warning off'
 - 'INT EFS off'
 - 'INT off'

If the above checks are okay, try to locate the fault using the diagnostic facilities.

17.5.1 The LED of EFS card is always OFF

Check the voltage supply of the EFS clutch. It should be in the range 24 Vdc - 240 Vac.

17.5.2 The electronics of electric actuator do not switch on when powered

- Check that the value of the main voltage on terminals L1, L2, L3 is correct.
- Remove the cover of the compartment where the electronic cards are located.
- Check the fuse mounted on the power card. Replace it if burned.
- If the fuse is okay, check the wires between terminals L1, L2, L3 and connector M1 of the power card. If it is correct, replace the power card.

17.5.3 DC output voltage not available at the terminals

- Switch the main power supply off and disconnect all wires from terminals B1-B2 and C1.
- Switch the main power supply on and check if the voltage on the terminals B1-B2 and C1 is between 23 and 27 Vdc.
- If the voltage is correct check the external wiring and the electrical load. It should not exceed 4W.
- If the voltage is not correct replace the power card.

17.5.4 The actuator does not work from remote controls

- Check that manual override selector is in AUTO and the LED in the clutch compartment is green.
- If the alphanumeric display indicates 'INT', an interlock control is present. Move the 3-position selector to LOCAL and check that the actuator works from local controls.
- Move the local selector to REMOTE. Check the signal on terminals B3, B4 and B5.
- Check that:
 - The wiring to terminals B1-B2 and C1 is correct
 - There is no short-circuit between wires
 - The electrical load does not exceed 4W
 - The value is in the range 20-120 Vac 50/60Hz or 20-125 Vdc, if external voltage supply is used

17.5.5 The motor is very hot and does not start

- Check that no alarm other than motor overheating is present.
- Wait until the motor cools down and the normally closed contact of the thermal switch automatically resets before trying to operate the actuator again.
- Check that the number of operations per hour and their duration is suitable for the actuator service (see the nameplate menu).
- Check that the valve operating torque is within the range of the unit's designed operating torque.
- Always check the causes of abnormal operation.

17.5.6 The valve does not seat correctly

- If the valve is stopped by the torque limit in closing, increase the actuator output torque limit.
- If the valve is stopped by the position limit in closing, check that the valve reaches its seat position, and then readjust the setting of the position limit.
- The internal trim of the valve may be damaged.

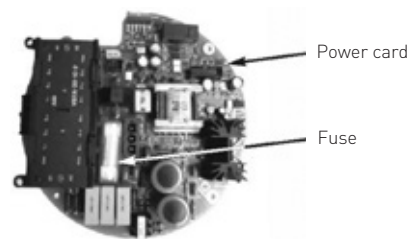

BIFFI FAIL SAFE ELECTRIC ACTUATORS, MODEL EFS2000V4

INSTRUCTION AND OPERATING MANUAL

17.5.7 Excessive torque for valve operation

- Clean, lubricate and check the valve stem.
- Valve packing too tight: loosen the gland bolt nuts.
- Coupling type 'A': tight fit between bush and stem: increase the thread clearance on the drive coupling.
- Coupling types 'B1', 'B2', 'B3' and 'B4': ensure there are no axial forces on the valve stem by leaving an adequate axial clearance between the stem and the drive bush. Also check that all transmission shafts, universal joints or bulkhead passages have sufficient lubrication and check that the transmission shafts are not bent.
- Check that the internal valve trim or the reducer gears are well lubricated and not damaged.
- Check the alphanumeric display for diagnostic messages, and proceed with the suitable corrective actions as described in chapter 17.5.11.

17.5.8 The actuator does not stop in fully open or fully closed position

- Check that the actual open and close positions of the valve respectively correspond to 100% and 0% on the actuator display
- Make sure that the torque and travel limits are correctly set (see 'Set-up routines, actuator setup, set stroke limits').

17.5.9 The numeric position display indicates 'E01'

- It is necessary to re-calibrate the stroke limits (see 'Set-up routines, actuator setup, set stroke limits').

17.5.10 Diagnostic messages

The alarm and warning lists contain the alarms and warnings momentarily present. Warning is the condition that occurs when a variable reaches a critical value and/or when a maintenance action is required, but all actuator functions are still available. The flashing of the alarm/warning LED indicates a warning condition. Alarm is the condition that occurs when a variable is outside the acceptable range and some actuator function is not available. If the alarm/warning LED is on there is an alarm condition. When the fault condition disappears, the corresponding alarm or warning also disappears from the list. A reset routine is provided to clear the types of alarms and warnings that are memorized (over-torque, jammed valve, etc.).

View procedure

- Move the 3-position selector to either OFF or REMOTE, and then press NO to scroll through the list of available variables.
- Press YES when the display shows message 'ALARMS view?' Press YES to scroll through the list of alarms.
- Press NO when the display shows message 'ALARMS view?'.
- Press YES when the display shows message 'WARNINGS view?' Press YES to scroll through the list of warnings.
- Press YES to reset the alarms or warnings with memory.

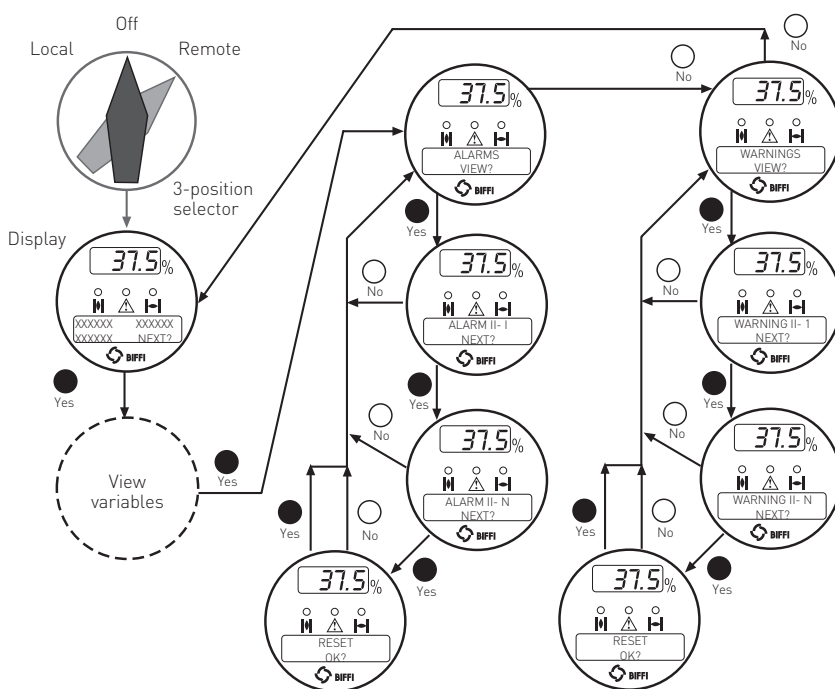

BIFFI FAIL SAFE ELECTRIC ACTUATORS, MODEL EFS2000V4

INSTRUCTION AND OPERATING MANUAL

17.5.11 Alarm table

Available controls

| Display message | Condition for alarm | Action | Local | Remote | Alarm reset |
|---------------------------|---|---|-----------------------------|-----------------------------------|---|
| High torque in closing | Measured torque greater than the relevant value configured in torque set-up or stroke limits routine | Operate the actuator in opening direction. Check the torque needed to operate the valve | Only open | Only open | Open, control |
| High torque in opening | Measured torque greater than the relevant value configured in torque set-up or stroke limits routine | Operate the actuator in closing direction. Check the torque needed to operate the valve | Only close | Only close | Close, control |
| Jammed valve in closing | No position change after receiving a close control | Check status of actuator and valve mechanical parts | Only open | Only open | Open, control |
| Jammed valve in opening | No position change after receiving an open control | Check status of actuator and valve mechanical parts | Only close | Only close | Close, control |
| Motor thermostat | Motor thermostat open for high temperature in the motor windings | Wait until the motor cools down | Not available | Not available | When thermostat closes |
| Internal temperature | Temperature inside the actuator enclosure higher than 90°C or lower than -40°C | Ambient temperature too high or too low. Verify insulation among actuator and heat source | Not available | Not available | Control temperature <90°C or >-40°C |
| Position sensor not valid | Value of the actuator position | Replace position sensor or recalibrate both stroke limits | Not available | Position signal correct | |
| Speed sensor | Measure of motor speed not valid | Replace speed sensor | Not available | Not available | Speed signal correct |
| Mid travel alarm in OP | The valve does not move in presence of an open control | Check status of actuator and valve mechanical parts. Recalibrate both stroke limits | Only close | Only close | Close, control |
| Mid travel alarm in CL | The valve does not move in presence of a close control | Check status of actuator and valve mechanical parts. Recalibrate both stroke limits. | Only open | Only open | Open, control |
| Main voltage | Main voltage lower than -20% or higher than +20% of the value stated in the nameplate menu | Check main voltage supply and frequency on terminals L1, L2 and L3. Check that wires section is correct | Not available | Not available | Main voltage correct |
| K1 contactor | The test routine reports a failure of K1 (coil or auxiliary contact) | Check the contactor | Opposite direction | Opposite direction | Control in opposite direction |
| K2 contactor | The test routine reports a failure of K2 (coil or auxiliary contact) | Check the contactor | Opposite direction | Opposite direction | Control in opposite direction |
| Configuration object nr. | The check sum of the EEPROM memory that contains the configuration data is wrong | Re-configure all parameters (see next page) | Not available | Not available | Memory okay |
| Hardware nr. | The diagnostic program detects some malfunction in the electronics controlling the actuator | Some circuit is damaged and does not work (see details next page) | Not available | Not available | Hardware okay |
| Low lithium battery | The voltage of the lithium battery is too low (only detected if the battery is present and the relevant parameter of the miscellaneous routine is set to 'present') | Change lithium battery | Available with main voltage | Available with main voltage | Lithium battery okay |
| Lost phase | The alarm appears only with 3-phase main supply. The alarm is generated in case of fault of one of the phases that supply the actuator transformer | Check main power supply on terminals L1, L2 and L3 | Not available | Not available | Phase okay |
| Request signal | The analog 4-20 mA signal is not correct | Check the external 4-20 mA generator and wiring | Available | Positioner function not available | 4-20 mA input okay |
| EFS mid travel | The position is >4% in ESD action and often 3*reset time | Check reset time. Check electrical stroke limits. Check mechanical stops | Not available | Not available | Electrical actuator command after the clutch has been re-energized or by local operator interface |

BIFFI FAIL SAFE ELECTRIC ACTUATORS, MODEL EFS2000V4

INSTRUCTION AND OPERATING MANUAL

17.5.12 Warning table

| Display message | Condition for warning | Action | Local | Remote | Warning reset |
|------------------------------------|--|--|-----------|-----------|--|
| High torque in OP (near max) | Measured torque 10% lower than the relevant value configured in torque set-up or stroke limits routine | Check the torque necessary to move the valve | Available | Available | Close, control |
| High torque in CL (near max) | Measured torque 10% lower than the relevant value configured in torque set-up or stroke limits routine | Check the torque necessary to move the valve | Available | Available | Open, control |
| Internal temperature (near limits) | Temperature inside the actuator enclosure higher than 80°C or lower than -35°C | Find the heat source and insulate the actuator | Available | Available | Control temperature > -35°C or <80°C |
| Main voltage (near limits) | Value of the main voltage out of the correct range (-15% or +10% of the value stated in the nameplate menu) or wrong frequency | Check section of wires and values of voltage and frequency | Available | Available | Main voltage correct |
| (Max) contactor cycles | Maximum number of contactor cycles reached | Change contactor and reset operation log | Available | Available | Clear recent data log |
| Maintenance request | Date of the next maintenance reached | Perform maintenance and set next maintenance date | Available | Available | Change date |
| Motor current | Motor current higher or lower than limits | Check electrical motor | Available | Available | Current okay |
| Wrong stroke limits | The routine that monitors the stroke limits detects a wrong end of travel condition | Recalibrate both stroke limits | Available | Available | Recalibrate both stroke limits |
| Bus | Fieldbus not working | Check bus communication | Available | Available | Bus okay |
| PST | PST cycle aborted | Check if condition to abort has happened | Available | Available | New PST cycle or by local operator interface |
| T-PST | T-PST value failed | Check baseline values and parameter T-PST | Available | Available | new PST cycle or by local Operator interface |
| T-RET | T-RET value failed | Check baseline values and parameter T-RET | Available | Available | New PST cycle or by local operator interface |
| OV-TR | OV-TR value failed | Check PST travel and parameter OV-TR | Available | Available | New PST cycle or by local operator interface |

Configuration object nr.: Number indicates the number of the parameters to be configured. To clear the alarm the table of all ICON2000 parameters is necessary. Please contact Biffi after sales service to solve the problem.
If the alarm message is 'CONFIGURATION OBJ 9999' only one of the ICON2000 parameters needs to be changed. For instance: enter the SET-UP menu, actuator set-up, torque set-up, and either increase or decrease the closing torque by 1%. As the alarm message disappears re-enter the SET-UP menu, actuator set-up, torque set-up, and set the previous value [see paragraph 9.1.2. of document BIFRM-0003-EN: 'Set-up routines, actuator set-up, torque set-up'].

Hardware nr.: Number indicates the module that is not working. The problem may be due to a malfunction of the module, to an incorrect wiring between modules, or to an incorrect configuration of the ICON2000. Please contact Biffi after sales service to solve the problem. The following hardware alarms can be detected:

- Hardware 1 = incorrect coding of local push buttons and selector
- Hardware 2 = incorrect configuration of Ain/Aout optional module
- Hardware 3 = no communication between Ain/Aout optional module and base card
- Hardware 4 = incorrect configuration of type of terminal board
- Hardware 5 = no communication between terminal board and base card
- Hardware 6 = incorrect configuration ICON2000/F01-2000
- Hardware 7 = incorrect configuration of type of bus card
- Hardware 8 = no communication between bus card and base card
- Hardware 9 = EFS clutch card failure
- Hardware 10= no communication between EFS clutch card and base card

18 EXPLODED VIEW AND PARTS LIST

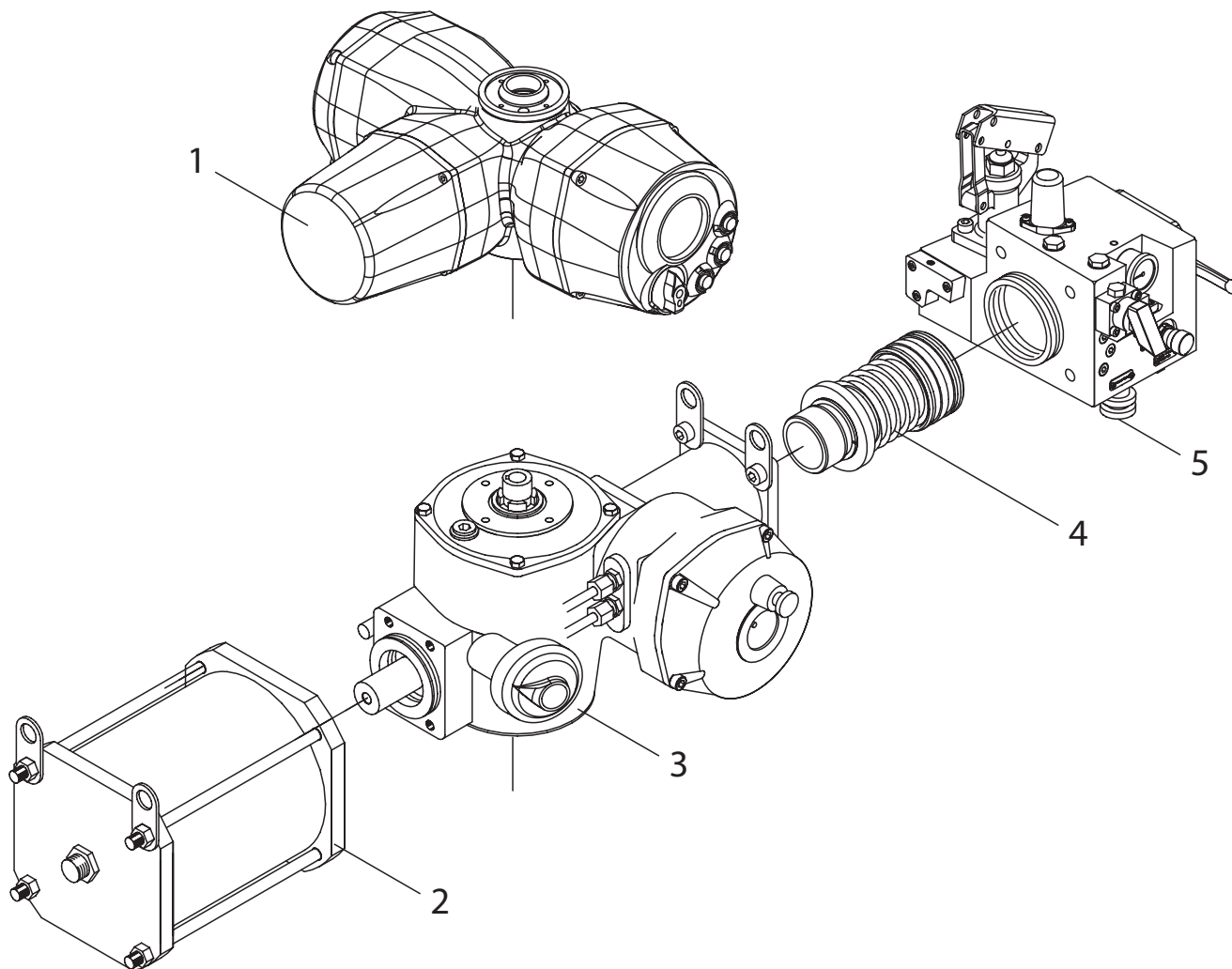

PARTS LIST

| Item | Quantity | Description | Material |
|------|----------|------------------------------------|----------|
| 1 | 1 | Icon2000 electric actuator | - |
| 2 | 1 | Spring cartridge | - |
| 3 | 1 | Electric actuator failsafe | - |
| 4 | 1 | Spring to close hydraulic actuator | - |
| 5 | 1 | Hydraulic control group | - |

BIFFI FAIL SAFE ELECTRIC ACTUATORS, MODEL EFS2000V4

INSTRUCTION AND OPERATING MANUAL

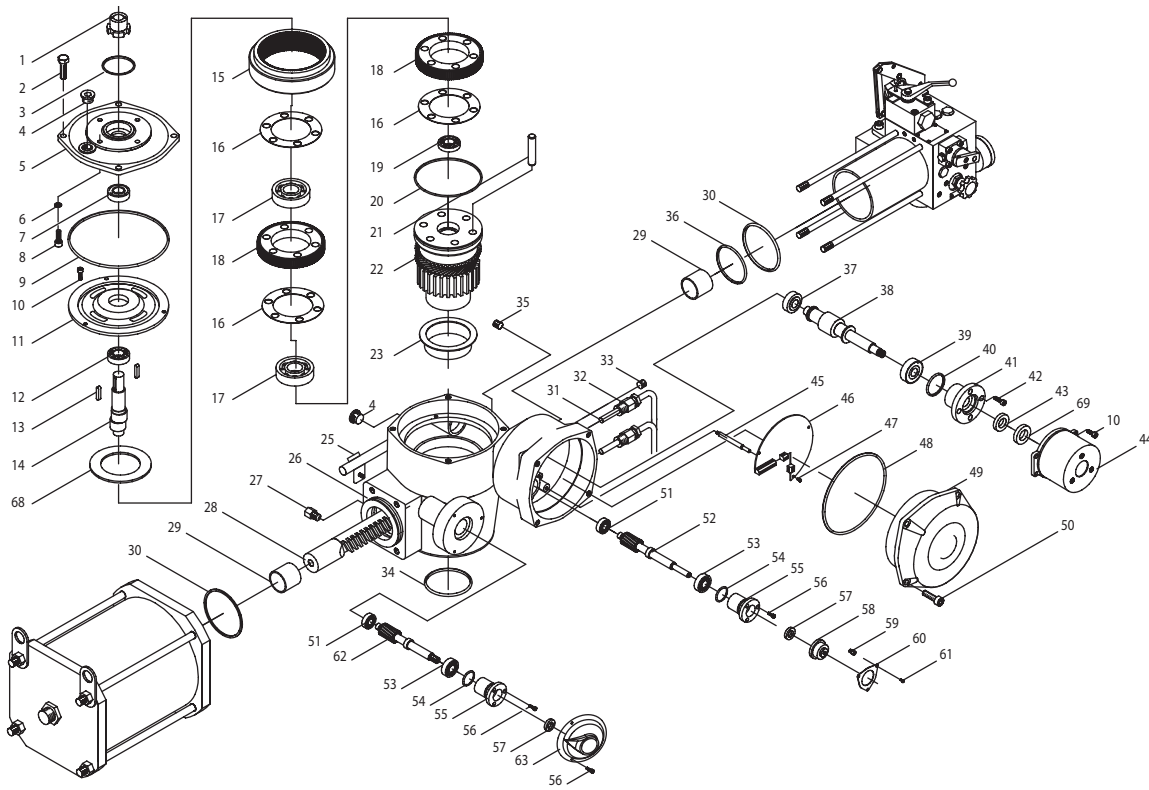

PARTS LIST

| Item | Qty | Description | Material | Item | Qty | Description | Material | Item | Qty | Description | Material |
|------|-----|------------------------|-----------------|------|-----|-------------------------------|-------------------|------|-----|------------------------------|-----------------|
| 1 | 1 | Insert | Carbon steel | 27 | 1 | Rock | Alloy steel | 53 | 4 | Screw | Stainless steel |
| 2 | 4 | Screw | Stainless steel | 28 | 2 | Bush | Steel-PTFE-Bronze | 54 | 1 | Seal ring | NBR rubber |
| 3 | 1 | O-ring | NBR rubber | 29 | 2 | O-ring | NBR rubber | 55 | 1 | Bearing | Carbon steel |
| 4 | 2 | Oil pug | - | 30 | 1 | O-ring | NBR rubber | 56 | 4 | Screw | Stainless steel |
| 5 | 1 | Housing cover | Aluminium | 31 | 1 | Cable gland assembly | - | 57 | 1 | Clutch assembly | - |
| 6 | 4 | Seal washer | - | 32 | 1 | Plug | Carbon steel | 58 | 3 | Column | Stainless steel |
| 7 | 1 | Seal ring | NBR rubber | 33 | 1 | O-ring | NBR rubber | 59 | 1 | EFS card | - |
| 8 | 4 | Screw | Stainless steel | 34 | 1 | External cylinder | Carbon steel | 60 | 3 | Screw | Stainless steel |
| 9 | 1 | O-ring | NBR rubber | 35 | 4 | Screw | Stainless steel | 61 | 1 | O-ring | NBR rubber |
| 10 | 8 | Screw | Stainless steel | 36 | 1 | Seal washer | Plastic | 62 | 1 | Cover | - |
| 11 | 1 | Worm wheel cover | Aluminium | 37 | 1 | Washer | Carbon steel | 63 | 4 | Screw | Stainless steel |
| 12 | 1 | Bearing | Carbon steel | 38 | 1 | Nut | Carbon steel | 64 | 2 | Bearing | Carbon steel |
| 13 | 2 | Key | Carbon steel | 39 | 1 | Adjusting screw | Carbon steel | 65 | 1 | Position transmitter shaft | - |
| 14 | 1 | Double eccentric shaft | Alloy steel | 40 | 1 | Screw | Carbon steel | 66 | 2 | Bearing | Carbon steel |
| 15 | 1 | Worm wheel | Carbon steel | 41 | 2 | Guide sliding ring for piston | PTFE+Graphite | 67 | 2 | O-ring | NBR rubber |
| 16 | 3 | Seal ring | Nylon | 42 | 1 | Piston | Carbon steel | 68 | 2 | Position transmission flange | Aluminium |
| 17 | 2 | Bearing | Carbon steel | 43 | 1 | Piston seal ring | PTFE+Graphite | 69 | 9 | Screw | Stainless steel |
| 18 | 2 | Gear | Alloy steel | 44 | 1 | Piston screw | Stainless steel | 70 | 2 | Seal ring | NBR rubber |
| 19 | 1 | Bearing | Carbon steel | 45 | 1 | O-ring | NBR rubber | 71 | 1 | Potentiometer assembly | - |
| 20 | 6 | Pin | Alloy steel | 46 | 1 | Piston Plug | Carbon steel | 72 | 3 | Spacer | Stainless steel |
| 21 | 1 | Splined bush | - | 47 | 1 | Bearing | Carbon steel | 73 | 1 | Potentiometer flange | Stainless steel |
| 22 | 1 | Bush washer | Bronze | 48 | 1 | Worm shaft | Alloy steel | 74 | 3 | Screw | Stainless steel |
| 23 | 1 | Bush | Fiberglide | 49 | 1 | Cable support | - | 75 | 3 | Nut | Stainless steel |
| 24 | 1 | Lever assembly | - | 50 | 1 | Bearing | Carbon steel | 76 | 1 | Position shaft | - |
| 25 | 1 | Housing | Cast iron | 51 | 1 | O-ring | NBR rubber | 77 | 1 | Position indicator | - |
| 26 | 1 | Silencer | - | 52 | 1 | Worm shaft flange | Aluminium | 78 | 3 | Screw | Stainless steel |

BIFFI FAIL SAFE ELECTRIC ACTUATORS, MODEL EFS2000V4
 INSTRUCTION AND OPERATING MANUAL

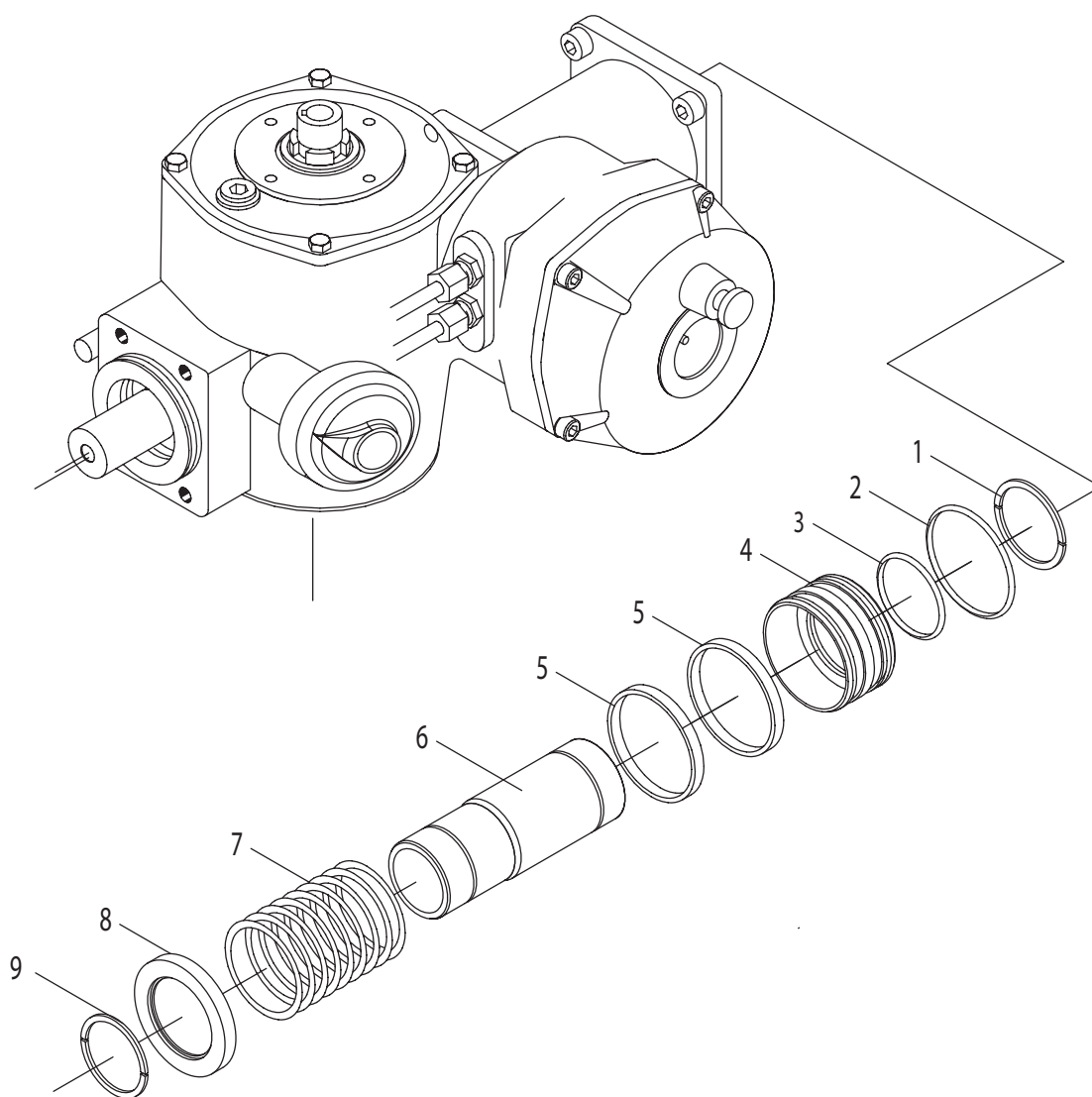

PARTS LIST

| Item | Quantity | Description | Material |
|------|----------|------------------------------------|-----------------|
| 1 | 1 | Circlip | Stainless steel |
| 2 | 1 | O-ring | NBR rubber |
| 3 | 1 | O-ring | NBR rubber |
| 4 | 1 | External piston | Aluminium |
| 5 | 2 | Guide sliding external piston ring | PTFE-Graphite |
| 6 | 1 | Internal cylinder | Carbon steel |
| 7 | 1 | Spring | Alloy steel |
| 8 | 1 | Support ring | Aluminium |
| 9 | 1 | End ring | Stainless steel |

BIFFI FAIL SAFE ELECTRIC ACTUATORS, MODEL EFS2000V4
 INSTRUCTION AND OPERATING MANUAL

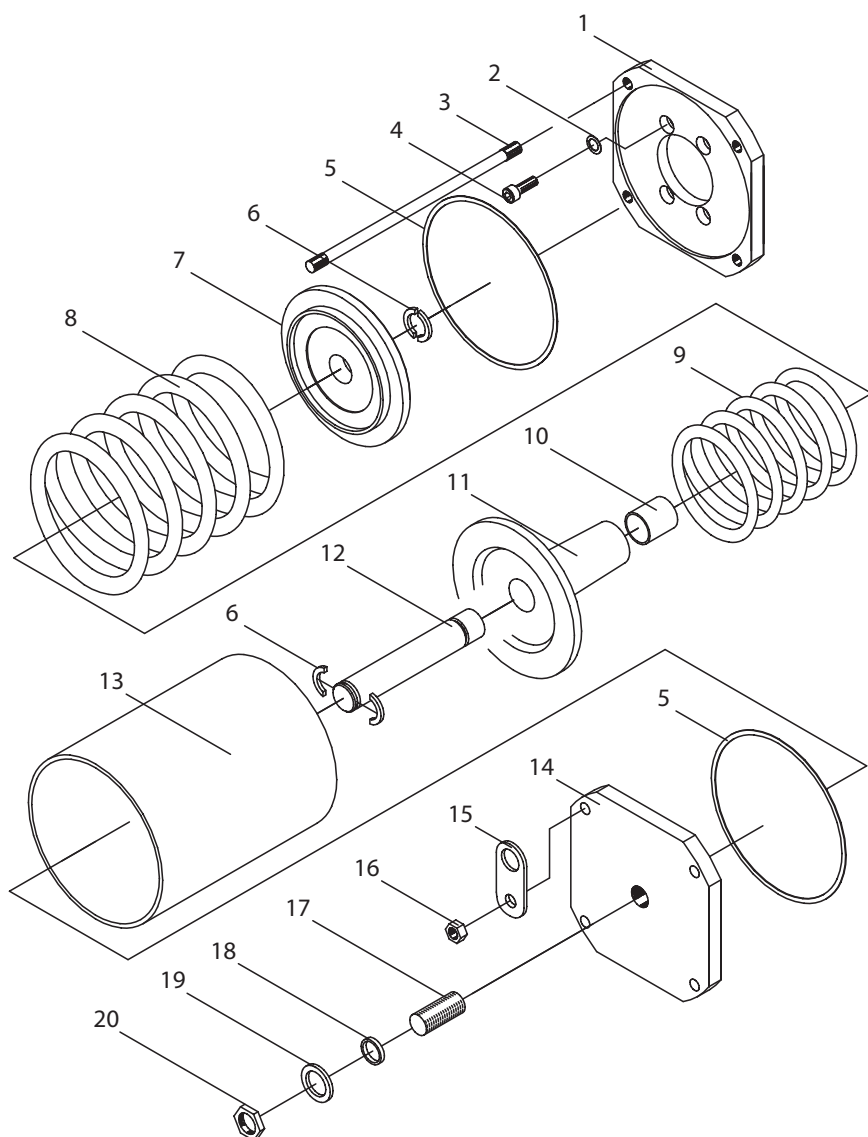

PARTS LIST

| Item | Quantity | Description | Material |
|------|----------|-----------------------|--------------------------|
| 1 | 1 | Head spring flange | Carbon steel |
| 2 | 4 | Washer | - |
| 3 | 4 | Tie Rod | Alloy steel |
| 4 | 4 | Screw | Alloy steel |
| 5 | 2 | Gasket | Fiber |
| 6 | 4 | Retainer ring | Stainless ring |
| 7 | 1 | Spring thrust flange | Cast iron |
| 8 | 1 | Spring | Alloy steel |
| 9 | 1 | Spring | Alloy steel |
| 10 | 1 | Bush | Carbon steel-Bronze-PTFE |
| 11 | 1 | Spring guide flange | Cast iron |
| 12 | 1 | Spring guide rod | Alloy steel |
| 13 | 1 | Spring cartridge tube | Carbon steel |
| 14 | 1 | Spring cartridge tube | Carbon steel |
| 15 | 2 | End spring flange | Carbon steel |
| 16 | 4 | Nut | Carbon steel |
| 17 | 1 | Adjusting screw | Carbon steel |
| 18 | 1 | Gasket | NBR rubber |
| 19 | 1 | Washer | Carbon steel |
| 20 | 1 | Nut | Carbon steel |

BIFFI FAIL SAFE ELECTRIC ACTUATORS, MODEL EFS2000V4

INSTRUCTION AND OPERATING MANUAL

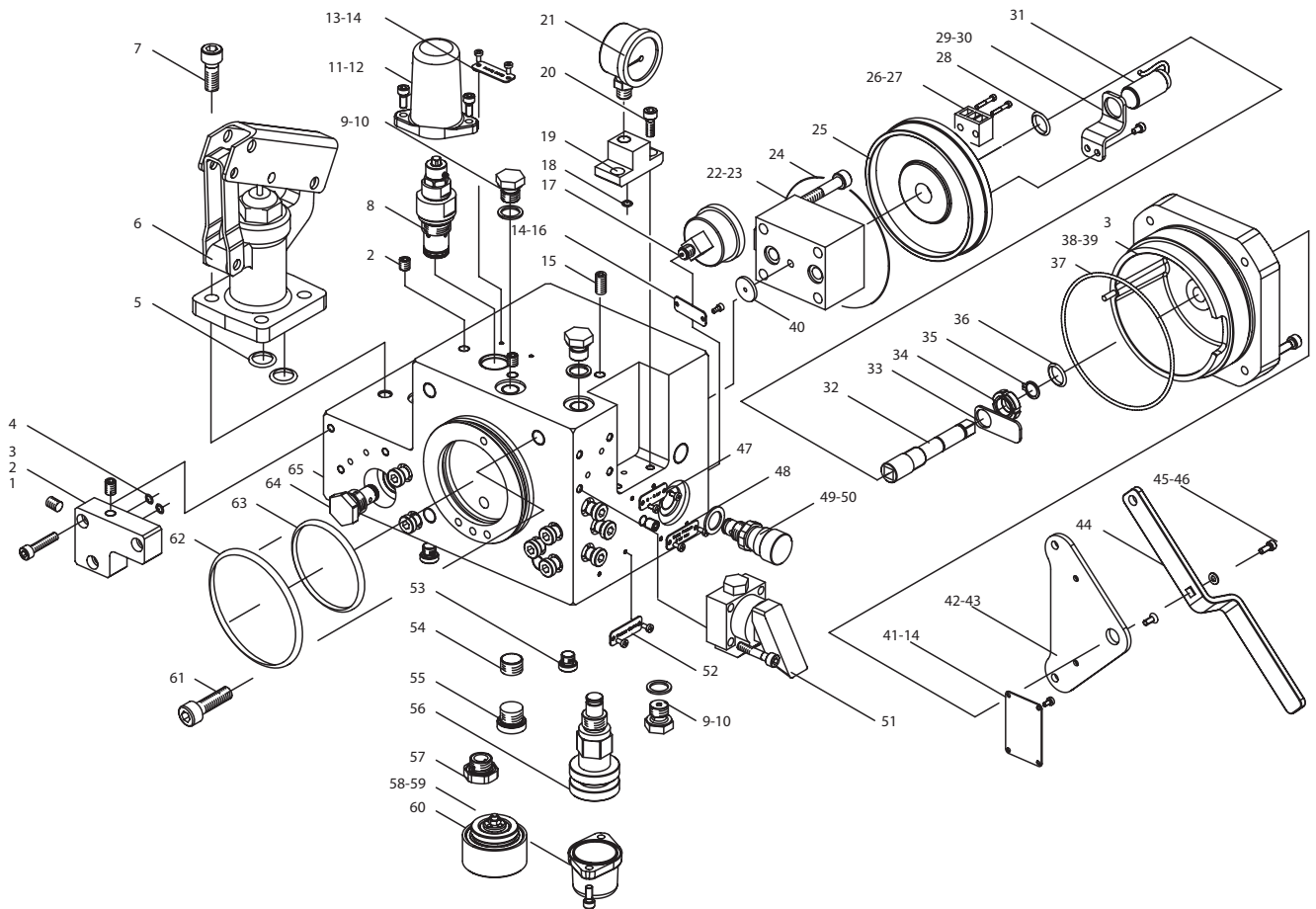

PARTS LIST

| Item | Qty | Description | Material | Item | Qty | Description | Material | Item | Qty | Description | Material |
|------|-----|---------------------------------|-----------------|------|-----|-------------------------|-----------------|------|-----|--|-----------------|
| 1 | 1 | By pass flange | Stainless steel | 23 | 4 | Screw | Stainless steel | 45 | 1 | Screw | Stainless steel |
| 2 | 9 | Plug | Stainless steel | 24 | 1 | O-ring | NBR rubber | 46 | 1 | Washer | Stainless steel |
| 3 | 8 | Screw | Stainless steel | 25 | 1 | Cover | Aluminium | 47 | 1 | Name plate | Stainless steel |
| 4 | 2 | O-ring | NBR rubber | 26 | 1 | Terminal | - | 48 | 1 | Name plate | Stainless steel |
| 5 | 2 | O-ring | NBR rubber | 27 | 2 | Screw | Stainless steel | 49 | 1 | Flow control valve | - |
| 6 | 1 | Hand pump | - | 28 | 1 | O-ring | NBR rubber | 50 | 1 | Seal ring | - |
| 7 | 4 | Screw | Stainless steel | 29 | 1 | Sensor support | Stainless steel | 51 | 1 | 2/2 N.C. hand operated spring return valve | - |
| 8 | 1 | Adjustable flow regulator | - | 30 | 2 | Screw | - | 52 | 1 | Name plate | Stainless steel |
| 9 | 3 | Drain plug | Stainless steel | 31 | 1 | Proximity sensor | - | 53 | 18 | Plug | Stainless steel |
| 10 | 3 | Seal washer | Stainless steel | 32 | 1 | Selector shaft | Stainless steel | 54 | 1 | Flow regulator | - |
| 11 | 1 | Adjustable flow regulator cover | Aluminium | 33 | 1 | Auto/manual indicator | Stainless steel | 55 | 1 | Plug | Stainless steel |
| 12 | 4 | Screw | Stainless steel | 34 | 1 | Ring nut | Stainless steel | 56 | 1 | Relief valve | - |
| 13 | 1 | Name plate | Stainless steel | 35 | 1 | Circlip | Stainless steel | 57 | 1 | Check valve | - |
| 14 | 14 | Screw | Stainless steel | 36 | 1 | O-ring | NBR rubber | 58 | 1 | Relief valve cover | Aluminium |
| 15 | 2 | Screw | Stainless steel | 37 | 1 | O-ring | NBR rubber | 59 | 1 | O-ring | NBR rubber |
| 16 | 1 | Name plate | Stainless steel | 38 | 1 | Upper cover | Aluminium | 60 | 4 | Relief valve | - |
| 17 | 1 | Gauge | - | 39 | 1 | Pin | Carbon steel | 61 | 4 | Screw | Stainless steel |
| 18 | 1 | O-ring | NBR rubber | 40 | 1 | Centering washer | Stainless steel | 62 | 1 | O-ring | NBR rubber |
| 19 | 1 | Gauge support | Stainless steel | 41 | 1 | Selector name plate | Stainless steel | 63 | 1 | O-ring | NBR rubber |
| 20 | 2 | Screw | Stainless steel | 42 | 1 | Selector locking flange | Stainless steel | 64 | 1 | Check valve | - |
| 21 | 1 | Gauge | - | 43 | 2 | Screw | Stainless steel | 65 | 1 | Manifold | Stainless steel |
| 22 | 1 | Auto/manual selector | - | 44 | 1 | Selector locking lever | Stainless steel | | | | |

BIFFI FAIL SAFE ELECTRIC ACTUATORS, MODEL EFS2000V4

INSTRUCTION AND OPERATING MANUAL

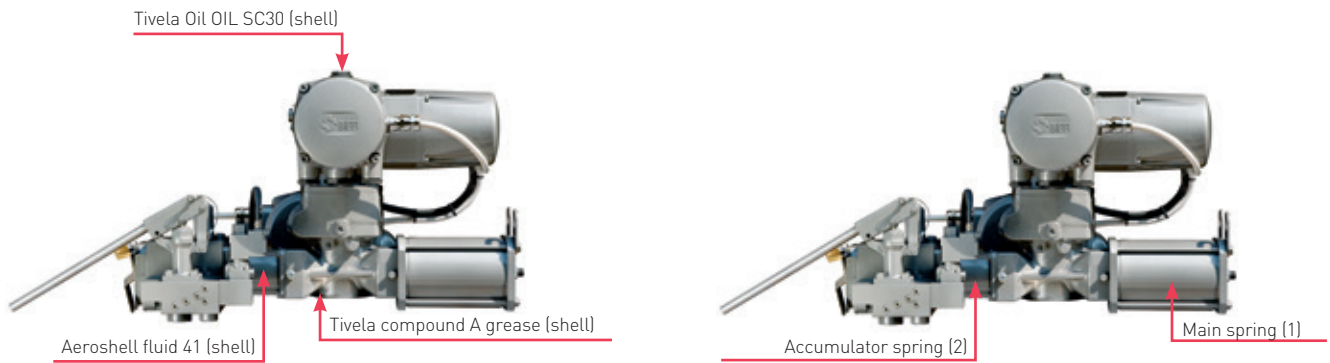

19 LUBRICATION

For normal duty the EFS2000v4 actuators are lubricated 'for life'.

The EFS2000v4 is composed by different compartments each of them are lubricated or filled by different products.

In case it is necessary to add lubricant, the following products (or equivalent) must be used.

20 OPERATIONAL TESTS AND INSPECTIONS

IMPORTANT

To ensure the guaranteed SIL Level, according to IEC 61508, the functionality of actuator must be checked with regular intervals of time, as described following.

For safety related applications, the following test operation has to be performed:

1. Full stroke of actuator once a year.
2. Partial stroking test at least every six months (if applicable, please refer to operating diagram and operate accordingly).
3. Visual inspection-checks, according to paragraph 17.1 with a frequency of once a year.

For standard applications please refer to paragraph 17.1.

21 DISASSEMBLING AND DEMOLITION

WARNING!

Before any disassembling, all the electrical supply connected to the EFS2000v4 must be disconnected.

WARNING!

The EFS2000v4 contains parts with springs, which may be under compression. Before any disassembling or for demolition, all precautions must be taken in order to be sure that the main spring (1) and the accumulator spring (2) are fully released. To be sure that all springs are fully released, put the hydraulic local selector in MANUAL position (see paragraph 16.2.2), remove the plug P and open the needle valve 352 (see paragraph 16.2.3).

WARNING!

Disassembling and demolition of spring pack MUST be done only by specialized personnel with suitable tools.



Biffi reserves the the right to change product designs and specifications without notice.

Biffi Italia S.r.L.

Località Caselle San Pietro, 420, 29017 Fiorenzuola d'Arda (PC) ITALY Ph: +39 (0)523 944 411 E-mail: biffi_italia@biffi.it www.biffi.it